

Hee Sook Lee-Niinioja

JAVANESE  
MOSQUE MIHRABS  
& Syncretic  
Islamic Ornament

NOVEL & NOBLE COMMUNICATIONS  
HELSINKI 2018



Hee Sook Lee-Niinioja

JAVANESE  
MOSQUE MIHRABS  
& S y n c r e t i c  
I s l a m i c O r n a m e n t

NOVEL & NOBLE COMMUNICATIONS  
HELSINKI 2018





© NOVEL&NOBLE COMMUNICATIONS

ISBN 978-952-7242-04-9 (PDF)

All rights reserved. No part of this publication may be reproduced or transmitted in any form or by any means, electronic or mechanical, including photocopy, recording or any other information storage and retrieval system, without prior permission in writing from the publisher.

Helsinki 2018



To God who endowed the meaning of life; Parents who inspired it; Family who supported it.

## F O R E W O R D

Java, situated on the southern Indonesian archipelago, has a tropical climate, abundant rainfall, and fertile soils, providing rich natural resources. The Hindu-Buddhist culture had influenced Java until Islam became the dominant religion in the 16<sup>th</sup> century. However, the basic patterns of ancestral and mythical beliefs integrated within Sufi Islam, which had lost much of its orthodoxy in its spread from the Arab world. Sacred pre-Islamic architecture became a means for Islamisation. Ornaments are not exceptional. For example, four pre-Islamic ornaments (prehistoric tumpal, Hindu-Buddhist kala-makara, lotus bud, scroll) continued to Javanese mosques, particularly on the most decorated mihrabs which are said to be ‘the gateway to the Heaven’.

This book investigates “Syncretic Islamic ornament on Javanese mosque mihrabs”, focused on the four motifs, in parallel with an examination of their continuing roles in Javanese tradition and cultural heritage. Moreover, as a better understanding of Islamic culture is unavoidable in current societies where many conflicts take place, this book can open up more dialogues between different beliefs and religions through the common culture and values.

This book is based on the researcher’s PhD from Oxford Brookes University in the UK (2006) and intends for education and research overall.

Hee Sook Lee-Niinioja, PhD

# C O N T E N T S

## Part One

Ornament Definition 3  
Islamic Ornament 5  
Regional Character 12  
Sacred Mihrab 17

## Part Two

Continuity of Pre-Islamic Ornament 20  
Elements & Principles of Design 21  
Transcendence of Prehistoric Tumpal 22  
Metamorphosis of Hindu-Buddhist Kala-Makara 28  
Imagination of Hindu-Buddhist Lotus Bud 34  
Harmony of Hindu-Buddhist Scroll with Islamic arabesque 39

## Part Three

Java: Indonesia 45  
Three Periods 49  
40 Javanese Mosque Mihrabs 50

Glossary 91  
Reference 93

## Part One

The extraction of part one is theories of ornament in general, Islamic ornament, and regional art in Java, establishing the foundation for syncretic pre-Islamic and Islamic ornament in Javanese mosque mihrabs.

### O R N A M E N T     D E F I N I T I O N

Concerning the definition of art in general and decoration in particular, Collingwood (1883) argues that if a man is instinctively interested in Nature and imitates her work to reveal his pleasure, it is art. If his interest and pleasure in Nature encourage him to work further by lingering passionately over the necessary form and colour and heightening the effects of strength or tenderness, it is decoration. As man adores Nature and loves her work by adorning it, decorative art is the expression of man's interest or pleasure in Nature and his work.<sup>(1)</sup>

The English word "ornament", derived from the Latin "*ornamentum*", interprets to confer grace on a ceremonial object. It refers to decoration or embellishment.<sup>(2)</sup> As an addition to their surroundings, objects of no particular use which give pleasure are called "ornament",<sup>(3)</sup> and a city itself can be an ornament in the broadest and highest sense of the landscape.<sup>(4)</sup> It has argued that ornament is how aesthetic beauty or symbolic significance imparts to the utility. Symbolic ornaments are composed of elements chosen for significance and aesthetic ones for beauty.<sup>(5)</sup> However, the general definition does not fully satisfy the essential qualities of ornament. It is a complex subject and is essential to understand its origin in artistic forms.

According to March's "Evolution and Psychology in Art" (1896), ornament rises from structural handicraft and then becomes fixed in our minds by contiguity; thus its transformation is increasingly expected. In other words, our hand and eye grow familiar with certain geometric lines and forms, but they are not an ornament, due to the basic structure. When our mind accustoms to their repeated appearances and searches for something missing in them, an ornament creates.

The origin of the ornament also traces to the Greek term "Kosmos" (universe, order, ornament). All classical motifs, either realistic or stylised, were originated from Nature. Nature produces acanthus, and the Ionic volute copies the helix of a snail or a seashell. Moreover, symbolic motifs are related to social life and mythology, such as egg and dart for representing life and death. They reflect social relationship which people have taken towards Nature and their gods. All ritual processions, figures, attributes, and images contribute to the iconographic heritage of

ornaments. For example, a tattoo is a visible way to signalise peoples' ranks and merits, to demonstrate their skills, and to protect them against devils. Immanuel Kant, one of the greatest German philosopher, says that 'ornament is ornament only when it suits the wearer'. It is part of the overall presentation of the wearer who carries it.

Ornament, like language, is originally bound up entirely with myth. It is only much later that it achieves its purely representational, purely 'aesthetic' role, only as the magic circle with which mythical consciousness surrounds it is broken.<sup>(6)</sup>

In opposition to this, Trilling (2001) argues of ornament for its beauty. For him, the ornament contains all the shapes and patterns that humans have employed to their buildings. It connects content and form. It is elaboration in which the visual appeal of form prefers to the emotional or intellectual one of content. The ornament is the only visual art for pleasure or beauty, imparting to the objects.<sup>(7)</sup> A border between architecture and ornament is that anything above the strictly functional and necessary one classifies as an ornament. The monumental ornament of columns in a Greek temple is a property of architecture, while ornamental cornices are decoration. Therefore, ornament should judge in conjunction with the whole building, and ornamentation must base on the close relation to all elements, namely the function of the construction, proportion, and materials.<sup>(8)</sup>

At any rate, ornament serves architecture, linking parts of an object to be the natural conclusion of the process-making, bringing life to the empty spaces of a building, and signifying the relationship of one part to another in a building. The church altar for worship is mostly decorated to be focused.<sup>(9)</sup> The meaning of 'ornament' changes in parallel with the development and conditions of culture. Ornament incorporates an inherent utilitarian form and acts as a visual system of configuring meanings. Focillon in his *The Life of Forms in Art* (1989) identifies ornament as 'the chosen home of metamorphoses'. Ornament lives a habitat that allows metamorphosis. Facts and expressions of utility have to transform within the space of any practical objects.<sup>(10)</sup>

Ornament evolves, sometimes slowly and incrementally, more really by quantum leaps, but even the slow evolution leads, in time, to something genuinely new.<sup>(11)</sup> ⊗

---

⊗ (1) Collingwood 1883 (2) Smeets 1975 (3) Bloomer 2002 (4) Smeets 1975 (5) Heath 1909 (6) Porphyrios 1991 (7) Trilling 2001 (8) Smeets 1975 (9) Snodin 1996 (10) Bloomer 2002 (11) Trilling 2001

Islamic ornament seems to be conceptual and intellectual rather than emotional, expressing contemporary ideas of beauty and aesthetic concepts to communicate Muslim thoughts and to reflect the spirit of their times.<sup>(1)</sup> In the context of a belief that ‘God alone is the Creator’, a new way of expression in ornament creates by the use of floral, geometric, and epigraphic motifs,<sup>(2)</sup> bringing ambiguity to their function as purely decorative, but also as possessing significant meaning. Islamic ornament was inherited from Byzantine and Sasanian culture and changed over time, stretching from Spain to India and Indonesia. It cannot understand without detailed studies of the regional, social, and temporal variations of the techniques and use of individual motifs.<sup>(3)</sup>

### Three Genres

The primary function of Islamic ornament is beautification to endow visual pleasure, despite many efforts of its symbolic connotation.<sup>(4)</sup> In this discussion, Brend (1991) argues that Islamic ornament rarely demands to be read as a symbol; rather it stands as an affirming background with a latent symbolism.<sup>(5)</sup> Hillenbrand (2001a) goes further, saying that Islamic ornament mainly beautifies structure, but can evoke a mystical idea too. As no constant association between particular buildings and symbolic connotations exists, ornament as the visual pleasure is often the first aspect of the buildings to consider.<sup>(6)</sup>

It has generally accepted that Islamic ornament consists of three genres: arabesque, geometry, and calligraphy. Arabesque is a stylised form of the vegetal scrolls,<sup>(7)</sup> signifying a concept of Paradise.<sup>(8)</sup> Kühnel in *Die Arabesque* (1949) argues arabesque as the most expressive artistic manifestation. In fact, over a long period, several debates on the term “arabesque” took place, ranging from the sole vegetal scrolls to the whole range of Islamic ornamentation.<sup>(9)</sup> The reluctance to depict living figures in the Islamic religious context (*Hadith*: Sayings of the Prophet) probably directed attention towards the creation of arabesque. However, it would be a mistake to regard them as fixed, because Islamic artists reinterpret nature through their creation. Arabesque characterises as ‘a form that is a plant and yet not a plant. Imagination, not observation, was the key; nature, it is true, but nature methodised’.<sup>(10)</sup>

Islamic ornament is best shown in geometric patterns whose basic devices are repetition, rotation, and reflection, evoking mystical thoughts.<sup>(11)</sup> The geometric mode often appears in basic forms, such as in angular repetitive grids, stellar patterns, and curvilinear networks on the windows. The eye is needed to appreciate the beautiful interlacement of the stonework and to trail the flow of intertwining forces.<sup>(12)</sup>

As the only novelty in three genres, calligraphy became the chief means of expressing symbolic connotation and aesthetic beauty.<sup>(13)</sup> Muslims understand it as a visible form of the

revealed Word of God, the Holy Koran. A fine script had to develop for serving Muslims' religious duty and the most appropriate ornamentation of buildings.<sup>(14)</sup> Moreover, epigraphic decoration intends to evoke mystery. In many of the most beautiful Islamic monumental inscriptions, their meanings are not precise, due to the rhythmic exuberance of the lettering and the pattern. Three genres of arabesque, geometry, and calligraphy are inter-related to maximise the beauty and symbolism in architecture. Epigraphic letters cramp into angular geometric forms. Vegetal arabesque unfolds concentrically or spirally. Geometric networks are edged, taken off their angularity by the use of buds or leaves. The distinctiveness of Islamic ornament can be the fact that the three genres infiltrate each other, creating ambiguity of their function.<sup>(15)</sup>

Islamic art is...a way of ennobling matter by means of geometric and floral patterns, united by calligraphic forms which embody the word of God as revealed in the sacred book, the Holy Koran.<sup>(16)</sup>

## Arabesque

Arabesque was identified during the 19<sup>th</sup> century as the primary characteristic of Islamic ornament by Orientalists who focused on the material culture of the Arabs in Syria, Egypt, North Africa, and Spain. The name was derived from the Italian word "rabesco" and applied during the Renaissance (1555) to refer to the Islamic style of ornamental pattern.<sup>(17)</sup>

In *Stilfragen (Problems of Style, 1893)*, Riegl limited the term "arabesque" to a stylised form of the vegetal and regarded it as the original creation of the Arab spirit. The key feature of arabesque was geometrisation of the stems of the particular vegetal elements. These can grow from one another infinitely in any direction, rather than branching off from a single continuous stem.<sup>(18)</sup>

According to Herzfeld in the first edition of *The Encyclopaedia of Islam* (1938), the term "arabesque" in its broader sense generally denotes the ornament of Muslim art but comprises several figurative elements. Therefore, the ornament can hardly be described and analysed as all the same, caused by the considerable differences in display across time and place.<sup>(19)</sup>

It was, however, Kühnel who claimed arabesque as the most expressive artistic manifestation in Islamic ornamentation, emphasizing its purely ornamental character. In *Die Arabeske* (1949), he does not accept Herzfeld's definition of arabesque. Instead, he adopts Riegl's theory of it as a vegetal type of ornament, which could intertwine with geometric, calligraphic, and stylised figural elements.<sup>(20)</sup> Kühnel further identified two aesthetic principles of arabesque: (i) rhythmical and harmonious movement, and (ii) filling the entire surface.

...whatever their origin and form may be, so it is also here that no symbolic meaning can be constructed. Decisive is a decorative intent which is devoid of a meaningful purpose.<sup>(21)</sup>



The function of arabesque was further analysed by Burckhardt (1976) that arabesque includes both stylised plant forms and geometrical interlacing work. The former expresses a perfect transcription of the law of rhythm into visual terms, the sense of rhythm, while the latter represents the spirit of geometry.<sup>(22)</sup> The idea of arabesque as solely decorative met opposition from Sufi scholars. Ardalan and Bakhtiar (1973) argued that arabesque recreates the cosmic processes of the Creator through nature. They held that a rhythmic component in arabesque reflects movement, manifests time, and symbolises the infinity, glorifying the concept of 'Garden of Paradise'. Combined with geometry and calligraphy, it exhibits a harmony of unity and multiplicity.<sup>(23)</sup>



Arabesque of the Umayyad dynasty, 9C (upper left); stucco-Ibn Tulun Mosque (upper right); mihrab frieze-Great Mosque of Cordoba <sup>(4)</sup>

Despite debates about its categorisation, arabesque in its vegetal form has been given the most attention. It is a distant relation of acanthus and vine scroll from the eastern Mediterranean area before the advance of Islam.<sup>(24)</sup> Curving vine scrolls first appeared in the Dome of Rock and Mshatta in the eighth century, and established in stucco and mosaic decoration of the Great Mosque of Cordoba two centuries later in the form of half-palmettes. By the 11<sup>th</sup> century, arabesque fully developed, as shown in the Great Mosque of Al-Hakim in Cairo, and then introduced to the Quwwat Al-Islam Mosque in Delhi, India in a combination of acanthus and Hindu lotus.<sup>(25)</sup>

First and foremost, the description of arabesque includes geometrical, but expressions of abstract and repetitive can be alternatives. Infinite, continuous, rhythmic, stylised and undulating are also favoured. Regardless of its function, whether beautification or symbolism, the creation of arabesque is likely to be the great achievement of Islamic ornament.

# Geometry

The Islamic art of geometric form, then, can be considered the crystallisation stage, both of the intelligence inherent in manifest form and as a moment of suspended animation of the effusion of content through form.<sup>(26)</sup>

The word “geometric” applies to three different kinds of form in Islamic ornament. In *The Mediation of Ornament* (1992), Grabar argues of three functions of geometry: (i) framing, (ii) filling, and (iii) linking motifs.

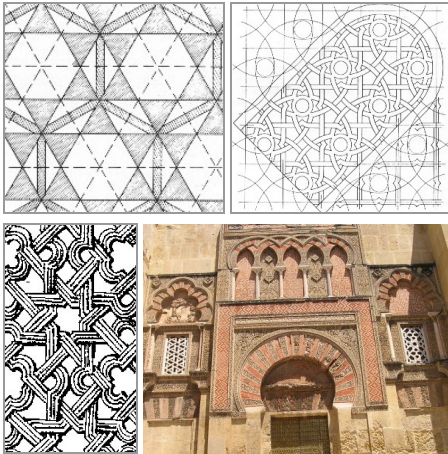

Geometrical patterns: pavement-Domus Augustana, Rome<sup>(b)</sup>; window grill-Great Mosque of Damascus 706-15<sup>(c)</sup>; window grill-Great Mosque of Cordoba 785<sup>(d)</sup>

The first form is a geometric pattern which appeared in mosaic tiles and stuccoes of the Alhambra in the 14<sup>th</sup> century. Despite changes in composition and reconstruction and different social and contextual meanings, geometry denotes a ‘regular’ element of creating a ‘regular’ pattern. The second is less rigid and more difficult to define than the first. In the Mshatta palace of the Umayyad, the majority of vegetal motifs are enclosed as a circular unit, making a regular outline, classed as geometric. The third is ‘loose’ geometry and includes all repetitive and rhythmic motifs which showed in border patterns on mosaic floors and in overall designs.<sup>(27)</sup>

The first form with stricter linear and geometric shapes have displayed in a variety of combinations in all periods. Geometric patterns were common to classical Greek and Roman designs, but Islam elaborated them in complexity and sophistication, transforming decorative geometry into a major art form. It demonstrates the fascination of Islamic artists with the visual

principles of repetition, symmetry, and continuous generations of pattern, clearly related to the study of mathematical calculations. All patterns were built up from a circle as a basic linear unit and a determining factor of the system of the proposition. The circle can be developed into a square, a triangle or a polygon, and elaborated further by multiplication, sub-divisions by rotation, and by symmetrical arrangements, giving prominence to decorated borders or other surfaces.<sup>(28)</sup>

Moreover, Islamic culture has proved itself best in the use of geometric patterns for artistic effect. Anyone contemplating its abstract patterns could associate them with mystical thought,<sup>(29)</sup> because geometric patterns reveal an aspect of the multiplicity of the Creator.<sup>(30)</sup> For example, roofs tend to be circular as a symbol of the cosmos, and a square floor implies the earth itself. Both in harmony signify infinity. Critchlow (1989) elaborates the symbolic circle. The lower half of the circle represents 'the world of sense', while the upper half expresses 'the world of being'. A circle corresponds to the Islamic view of creation.<sup>(31)</sup> The circle as a metaphor for Divine Unity is again stressed by Nasr (1987) that the Muslim love of geometry and number directly connects to the doctrine of Unity (al-tawhid). The sacred character of mathematics is evident in ornamentation which presents the One and the many.<sup>(32)</sup> On the other hand, Grabar (1992) views geometry as an intermediary for displaying aesthetic beauty:

Geometry...forces one to look and to decide what to think, what to feel, and see how to act...The penalty of freedom in the arts is a loss of meaning...It is meant only to be beautiful.<sup>(33)</sup>

## Calligraphy

Recite in the name of thy lord who created  
Created man from a clot;  
Recite in the name of thy lord,  
Who taught by the pen,  
Taught man what he knew not  
(The Koran, surah 96:1-5)

The only true novelty in Islamic ornament is calligraphy. It became a major vehicle for aesthetic energies and symbolic meanings because the word of God recorded in the Holy Koran.<sup>(34)</sup> Muslims understand that the use of a fine script (*kalle*, beautiful; *graphie*, writing) is not only their religious duty, but it also is the most appropriate ornamentation for a mosque building.<sup>(35)</sup> Forms and styles of calligraphy should be learned to underline epigraphy as a dominant factor. Its advantage lies in the variety of styles, depending on the nature and context of texts in different periods.<sup>(36)</sup> Holy inscription usually places where any Muslim viewer can see them and learn them

by heart, while an amalgam of lettering, texture, colour, and inscription embellishes the building.<sup>(37)</sup> Calligraphy can also identify a building or its builder or patron.<sup>(38)</sup>

Two main styles of calligraphy developed: (i) the script is known as *Kufic* from the name of the city Kufa in Iraq in the seventh century, and (ii) *Naskhi*, a word derived from signifying ‘to copy’, and its meaning is almost equivalent to ‘cursive’. *Kufic* is a rectilinear and angular form which fits for a specific aesthetic intention and scope. It customarily used in the Holy Koran with its vertical character and more geometric configuration than *Naskhi*.<sup>(39)</sup>

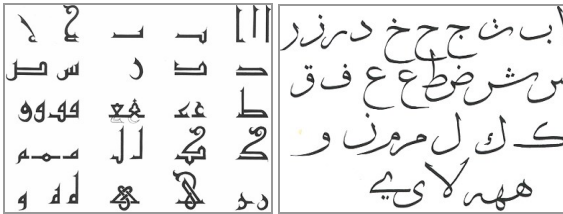

Two main styles: *Kufic*; *Thuluth*, a type of *Naskhi* style<sup>(40)</sup>

Up to the 12<sup>th</sup> century, *Kufic* was the only script utilised in the decoration of mosaics and carved stones, due to its monumental character, its easy transposition into different materials, and its straight lines and empathic uprightness. The first use of epigraphic decoration was in the Dome of the Rock in Jerusalem in 685-91.<sup>(40)</sup> The purest angular *Kufic* scripts seemed to be favoured in minarets and mosques, while ornamental *Kufic* on any surface.<sup>(41)</sup> *Naskhi*, a cursive form of writing, was invented by Ibn Muqla, and acquired its status as a major script at the hands of successive master calligraphers, such as Ibn al Bawwab and Yaqut al Musta'simi. The script was inherited from pre-Islamic and early Islamic scripts and appeared in a more systematized form at the end of the ninth century.<sup>(42)</sup> Less monumental than *Kufic*, it was mostly applied to inscriptions, rather than in decoration. However, its curves and oblique slants brought a supple and living element to architecture.<sup>(43)</sup>

Islamic calligraphy can consider ‘the geometry of line.’ The proportion of the letters and the curved strokes executed according to mathematical calculations. The term “spiritual geometry” describes both the structure of calligraphy and the whole essence and spirit of Islamic art. Mystical values are manifest in calligraphy as well as in arabesque and geometry. A Sufi belief in awareness of God’s presence and purpose in His creation exemplified in an iconic form in the art of calligraphy.<sup>(44)</sup> Calligraphy is likely to be the most potent means of expressing God’s message.

The very structure of calligraphy, composed of horizontal and vertical strokes woven into a fabric of profound richness, is potent with cosmological symbolism. The verticals...provide an ontological relationship as well as a structure for the design, while the horizontals...correspond to the creation that

develops the balance and flow of the basic conception. It is through the harmonious weaving of the horizontal and the vertical that unity is achieved. <sup>(45)</sup>

## Commonality

Similar expressions on three genres showed in different texts, such as geometric(al), linear, and mathematical, demonstrating the interactive quality of Islamic ornament.

arabesque	abstract, anti-natural, circular, continuous, curved, geometrical, infinite, linear, mathematical, mystical, regular, repetitive, rhythmic, symmetric
geometry	abstract, circular, continuous, geometric, linear, mathematical, mystical, regular, repetitive, rhythmic, symmetric
calligraphy	curved, geometric, rectilinear, mathematical, mystical

The definitions will use for analysing orthodox Islamic motifs on a section of 40 Javanese mosque mihrabs. <sup>⊗</sup>

---

⊗ (1) Mitchell 1978 (2) Hillenbrand 2001 (3) Grabar 1987 (4) Baer 1998 (5) Brend 1991 (6) Hillenbrand 2001a (7) Riegl 1893, Burckhardt 1976 (8) Ardalan and Bakhtiar 1973 (9) Kühnel 1949 (10) Hillenbrand 2001a (11) Irwin 1997 (12) Burckhardt 1980 (13) Hillenbrand 2001 (14) Davies 1982 (15) Hillenbrand 2001a (16) foreword by Nasr from Critchlow 1989 (17) Naddaff 1991 (18) Riegl 1893 cited by Kühnel 1949 (19) Herzfeld 1938 (20) Kühnel 1949 cited by Khazaie 1999 (21) Kühnel 1949 (22) Burckhardt 1976 (23) Ardalan and Bakhtiar 1973 (24) Burckhardt 1976 (25) D. Jones 1978 (26) Critchlow 1976 (27) Grabar 1992 (28) Burckhardt 1976, Irwin 1997, D. Jones 1978 (29) Irwin 1997 (30) Ardalan and Bakhtiar 1973 (31) Critchlow 1989 (32) Nasr 1987 cited by Necipoğlu 1995 (33) Grabar 1992 (34) D. Jones 1978, Grabar 1987, Hillenbrand 2001a (35) Davies 1982 (36) Burckhardt 1980 (37) Hillenbrand 1994; 2001a (38) D. Jones 1978 (39) Lee 2000 (40) Papadopoulo 1980 (41) Davies 1982 (42) Lee 2000 (43) Papadopoulo 1980 (44) Yeomans 1999 (45) Ardalan and Bakhtiar 1973: (a) Riegl 1893, Photo:Lee-Niinioja (b-c) Creswell 1989 (d) Marçais 1954, Photo:Lee-Niinioja (e) Lee 2000

# R E G I O N A L C H A R A C T E R

Regionalism looks for sustaining spiritual forces and refuses to accept that a tradition is a fixed set of devices and images... It...deals with climate, local materials and geography in epochs before the arrival of Islam. The aim is to unravel the layers, to see how indigenous archetypes have been transformed by invading forms, and in turn to see how foreign imports have been adapted to the cultural soil... Beyond the particular, the regionalist tries to see the type, the general law, the originating principle.<sup>(1)</sup>

Islamic culture and art have been influenced and remodelled by local traditions with countries which they came into contact to comply with its religious and philosophical ideas. This interaction has enriched both the material culture of the Muslim world and those pre-existing ones.<sup>(2)</sup> Despite keeping the Islamic principles in unity, gradual stylistic changes occurred, and the regional, social, and temporal variations in Islamic art and architecture should study in detail.<sup>(3)</sup>

Today, Southeast Asia (the Malay)<sup>1</sup> including Java represents almost one-quarter of Islam's global community. Islamic civilisation inextricably linked to the message of the Prophet since its arrival in Java in the early 15<sup>th</sup> century. Islam not only altered local cultural landscapes, but it also created a unique regional heritage. It can ask why a characteristic regionalism had to take place in this archipelago. Was it due to the awareness of continuing Javanese cultural heritage? It is that the long geographical distance between the Arab world and Southeast Asia prevented the direct influence of the Islamic centre into this region at the beginning.<sup>(4)</sup>

However, the expression of faith in art and architecture articulated the creed of Islam and produced the complexity of regional variations.<sup>(5)</sup> Two factors can argue in creating the regionalism. Firstly, living in a spirit of tolerance, flexibility, and openness, the Malay people could accept changes through careful selection, reflection, and modification without discarding their rich cultural traditions. They witnessed the Hindu-Buddhist, Chinese, Islamic, and western cultures which had a massive impact on the lifestyle.

Secondly, the arrival of Islam to the archipelago coincided with an era of zealous spiritualism in the Islamic world. Sufi mysticism had first appeared in Persia, and following the Mongol seizure of Baghdad in 1258, it rapidly spread through international trade routes.<sup>(6)</sup> As the Sufi precept of 'universal toleration' could negotiate with pre-Islamic culture,<sup>(7)</sup> a new Malay identity was quickly expressed in Malay art to affirm 'oneness of God'. Artists drew inspiration from the diverse heritage and chose to transform existing symbolism along with Islam.<sup>(8)</sup>

---

<sup>1</sup> The term "Malay" was first appeared in the Buddhist Sriwijaya, but altered to historical situations. Although the Malay world is sometimes synonymous with Islam, the regional circumstance makes it difficult to sustain (Bennett 2005). Here, "Malay" means Southeast Asia including Indonesia.



Indonesian mosques with regional multi-tiered roofs: Agung Demak, Java 1479; Lubuk Bauk, Sumatra; Sultan Abdurahman, Kallimantan; Tua Pulau Ternate, the Moluccas; Pondok Indah, Java 1997<sup>(a)</sup>

Moreover, the close relationship between rulers and Islam was spatially symbolised by placing Javanese palaces adjacent to the grand mosques and the town centres. The common heritage in many mosques reflects the close political relationship between Muslim rulers in different regions. Shared features are tripartite division (base, main body, superstructure), centralised plan, multi-tiered roof, sokoguru (four master columns), mustaka (crown), outer colonnade, serambi (veranda), walled courtyard with two gateways, drum, and graveyard.<sup>(9)</sup>

Until the late 19<sup>th</sup> century, mosques were constructed in a vernacular style. The persistence of indigenous buildings had to take into account the local profusion of natural resources and variable climates, resulting in exuberant and diverse architectural styles. Elements associated with Islamic architecture elsewhere, such as dome and geometric ornament, do not feature in these traditions. Hindu-Buddhist multi-tiered wooden roofs are the most suitable for tropical weather against heavy rain and humidity.<sup>(10)</sup> Sokoguru supports the uppermost roof, separating it from the double-layered outer roof to admit light and to allow ventilation of the prayer hall.<sup>(11)</sup>

As pre-Islamic traditions underline the form and setting of sacred places, mystical Sufis borrowed them, based on their belief of mosques to be holy, creating a combination of indigenous and Islamic ideas and forms in mosque architecture.<sup>(12)</sup> A three-tiered roof symbolises the mystical paths to God. Sokoguru signifies the spiritual context of the vertical unity between God and his believers, continued from the Hindu belief in the identity of self and the universal soul.<sup>(13)</sup>

According to a Malay perspective, art is likely to function as delight and purity. The main difference between Islamic art and Malay art is the level of religious values inherent in the artefacts. Despite the influence of pre-Islamic beliefs and art forms on the pattern of life in

Southeast Asia, a bond between Islam and local culture has been steadfast, because existing influences encouraged Malay people to accept Islamic ideologies and to develop a unique regional art. The concept of 'Godliness' of their ancestors and the primary aesthetics of cosmological belief in Malay were penetrated Islamic cosmology in the form of syncretic culture.<sup>(14)</sup>

The avoidance of figurative representation separates Islamic art from Hindu-Buddhist aesthetic style. Nevertheless, in this region, Islamic art needed reconciliation of the ambivalent relationship between the two religions, caused by the ruler's indigenous belief of the magic in art. Accordingly, the depiction of non-Islamic images such as Hindu deity Ganesha or zoomorphic and anthropomorphic symbols combined by Koranic calligraphy was understood in the context of the earlier animism. This method was intended to represent non-Islamic images fitting into an aesthetic attitude tolerable to Islamic orthodoxy. In the syncretic process, armed Ganesha resembled Ali's sword, discarding his Hindu iconography simultaneously. This change suggests a transformative possibility.

Another device was the metamorphosis of foliage into a figurative form, seen in a stone panel of Mantingan (1559) where leaves and tendrils became a shape of a monkey. Makaras (fish with the elephant trunk), disguised as foliate scrolls at Central Javanese temples, continued for the decoration of ceremonial boat prow in Islam, signifying protection and richness.<sup>(15)</sup> The preference of emblematic depiction brought a potentiality in ornamentation. Narrative realism was replaced by vegetal patterns of meandering clouds whose endless spiralling floral and foliate scrolls formed visual dynamism. The shift from figural representation to the frame decoration achieved its finest expression in the illuminated manuscripts, batik, and sculptured wood.<sup>(16)</sup>

In Islamic ornament, calligraphy awards a status higher than arabesque or geometry<sup>2</sup>. As the medium for transmitting the words of the Koran, Arabic script played a spiritually unifying role and was placed in a unique position among Muslims, regardless of their ethnic or social backgrounds. In Southeast Asia, calligraphy more often used in decorating the illuminated manuscripts, rather than the exploration of sophisticated calligraphic styles. The blessed Islamic phrases are to read for their association with the grace of the Koran, and inscriptions perceive as the potent image of blessing and protection. The image of talismanic textiles suggests the influences of Sufi metaphysics.<sup>(17)</sup>

Among many types of pre-Islamic motifs including a winged gate which appeared in early Javanese mosques, kala(lion)-makara and floral motif seemed to continue the most, particularly lotus flower. Islamic poets describe the flower as a book where one can study the knowledge about God. And its combination with birds can be considered as the characteristic of Islamic Javanese decorative art, despite the prohibition by *Hadith*. Interestingly, the winged gate neither

---

<sup>2</sup> Megalithic geometry and Hindu-Buddhist scrolls likely assimilated with Islamic geometry and arabesque. However Islamic ornaments became popular in the contemporary period of Java.



found in Hindu-Buddhist nor Islamic culture, but as a bird of the vehicle of Vishnu in Hindu myth, the motif could be the Javanese invention at the beginning of Islamisation.<sup>(18)</sup> The Chinese settlements and their role in the creation of Islamic aesthetic in the archipelago are apparent in works of art. In Sumatra, where many Chinese settled and adopted Islam, the art of lacquer-making highly developed. In the timber-rich coastal Java, they influenced existing traditions of woodcarving and distinct batik styles.<sup>(19)</sup>

Van Leur in his book *Indonesian Trade and Society* (1960) argues that Indonesian history must be understood in its terms, not in those borrowed from other cultures. This view seems to be shared by others: 'We are Javanese, then, our religion is Islam'.<sup>(20)</sup> Islamic art became an extension, rather than a radical change from earlier aesthetic traditions.<sup>(21)</sup> These comments raise a question: what is the different Javanese attitude to Islamic culture? The answer can be found in Kusno's article (2003)<sup>3</sup>, arguing that Java was the centre of the universe before the arrival of Islam, but on facing Islam, Java was aware of its limit. To keep a religious balance, the Javanese Muslims had to localize smoothly orthodox Islamic culture to continuing traditional symbolism; thus they could feel that the centre would not have to shift so radically.

Consequently, constructing a syncretic mosque of Agung Demak (1479) is likely to represent the power of the new faith in Java from the viewpoint of Islam. Islam has localized and incorporated into an element within the broader cultural framework of Java from the Javanese perspective. Java was not merely part of Islam, but Islam was part of Java or Javanese life.

This philosophy has continued until five centuries later. Mintobudoyo, a Javanese architect, designed Soko Tunggal (1973) at Taman Sari in Central Java. The mosque has a single column, supporting four corner beams of the upper roof. The architect intended to construct a focus, a vertical centre, which represents 'unity' of the Javanese and Islamic world. The vertical column pays tribute to global Islam, while the horizontal spread of four master pillars confirms the existence of local power. Surprisingly, the mosque orients itself to the east, away from qibla, and any deviation from this direction for a mosque would violate the Javanese rule. Indicated by a group of architectural historians in Indonesia, the architect clarified that it is Java, which is at the centre of the whole negotiation, and his idea was accepted. This story shows how the transformation of Javanese Islam, and its architectural form is inseparable from the social and economic contexts.<sup>(22)</sup>

---

<sup>3</sup> Kusno, Abidin (2003), "the Reality of One-Which-is-Two: Mosque Battles and Other Stories, Notes on Architecture, Religion and Politics in the Javanese World", *Journal of Architectural Education*, ACSA, Inc. pp. 57-67; Saliya, Hariadi and Tjahjono (1990), "Contemporary Expressions of Islam in Buildings: Indonesian Experience"



Sokoguru, Agung Demak 1479; sokotunggal, Taman Sari 1973; sokoguru/minaret, Agung Semarang 2004<sup>(6)</sup>

In 2004, Agung Semarang in Central Java inaugurated. It represents a modern Javanese mosque how the design principle can combine locality and Islam, nationalism and internationalism, and strictness and smoothness. Pre-Islamic sokoguru in the prayer hall extends through a roof, becoming minarets. And local floral motifs are designed according to the style of Islamic arabesque.<sup>(23)</sup> A return to the rich traditions of local culture corresponding to the pan-Islamic world starts visibly after 1945. Global solidarity of Islam and a unifying act of pilgrimage in the Arab world are in tension with the Javanese capacity to absorb and syncretise external elements. These factors can confuse attempts to distinguish and assess continuities and consistencies.<sup>(24)</sup>

Islamic cultural heritage reflects unity in diversity in Southeast Asia, where Java belongs. In appreciating its development, one should be mindful of the context of multicultural societies which created an extraordinarily rich practice through the integration of tradition, ethnicity, geographical space, and belief. It was due to the inspiration of the Malay people, which has played the most significant force in creating a regional Islamic culture and Malay identity in this archipelago.<sup>(25)</sup>

Regionalism in architecture is a concept of architectural design based on such determinants as the culture, the climate and the resources... The history of civilisation shows...region and culture-specific architecture...in different parts of the world.<sup>(26)</sup> ⊗

---

⊗ (1) Curtis 1988 (2) Rogers 2005 (3) Grabar 1987, Baer 1998 (4-5) Bennett 2006 interview and Bennett 2005 (6) Yatin 2005 (7) Bennett 2005 (8) Yatin 2005 (9) Fontein 1990 (10) Noe'man and Fanani 2005 interview (11) O'Neill 1994 (12) Tjahjono 1998 (13) Isnaeni 1960 (14) Yatin 2005 (15) Bennett 2005 (16) Yatin 2005 (17) Rogers 2005 (18) Marwoto 2003 (19) Bennett 2005 (20) Prijotomo 2004 interview (21) Bennett 2005 (22) Kusno 2003 (23) Fanani 2004 interview (24) O'Neill 1993 (25) Bennett 2005 (26) Mukhtadir 1988: (a) Web (b) Photo:Lee-Niinioja, Fanani 2004

# S A C R E D M I H R A B

It has said that mystical Sufis adopted pre-Islamic art traditions to create Javanese mosques with a sacred character. Among many elements in the mosque, a mihrab, a prayer niche, has been the most significant in terms of aesthetic and symbolic functions. Mihrab is an indentation at the point where the qibla axis meets the far wall of the mosque, taking the shape of an arch. Being both the visual and liturgical climax of the mosque where an imam (a religious leader) leads the congregation in prayer, mihrab usually decorates with lavish ornamentation. The mosque of the Prophet in Medina and the earliest mosques in the Umayyad dynasty had no mihrabs.<sup>(1)</sup>

Opinions on the origin of mihrab are various. It had a forerunner in the niches of Byzantine architecture.<sup>(2)</sup> Two origins are possible: (i) the prototype of the Torah-niche in the synagogue, where Jews kept the Scriptures, and (ii) the apse of Christian churches in early Coptic chapels in Egypt. It was combined with the triumphal arch over the tabernacle to show the symbolic presence of God.<sup>(3)</sup> Another theory suggests its origin as the place for a statue in the Greco-Roman temple or the apse in a church.<sup>(4)</sup>

The word “mihrab” reappears several times in the Holy Koran and had many meanings before becoming attached primarily to a niche in the back of the mosque. It is a place of honour, but is hard to know what meant in the context of the passage in the Holy Koran (surah 34:13). King Solomon, patron of works of art, ordered the molten brass, and jinns (spirits) manufactured for him ‘maharib’ (plural of mihrab, statues, cooking vessels, and tableware).<sup>(5)</sup>

They worked for him as he desired, high rooms, images, basins as large as reservoirs, and cauldrons fixed. ‘Work you, O family of Dawud, with thanks!’ But few of My slaves are grateful. (surah 34:13)

The word “mihrab” was also used concerning the divine character, in a paper of *Les mihrab et leurs ornements décoratives (the mihrabs and their decorative ornamentations)* at the international conference (1980) on mihrabs, held in Paris.<sup>(6)</sup>

Then he came out to his people from Al-Mihrab and he told them by signs to glorify Allah’s Praises in the morning and in the afternoon. (surah 19:11)

A concave mihrab was built in 707-09 when Al Walid of the Umayyad brought Coptic masons to Medina to rebuild the Prophet’s mosque. A Coptic devotional niche changed into a directional Islamic niche. Since then, mihrab had become the central feature of all sacred art and architecture in Islam. Unlike an altar, mihrab is not sacred itself but indicates the direction of prayer, which is sacred. For this reason, it is accorded extraordinary respect,<sup>(7)</sup> and is the most ornate feature of the mosque<sup>(8)</sup> with three types of Islamic decorative motif: vegetal, geometric, and epigraphic.<sup>(9)</sup>

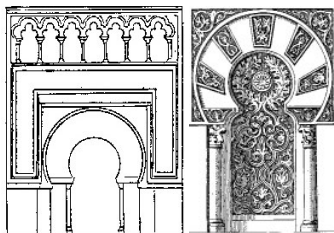

Mihrabs of the Great Mosque of Cordoba (left) and Madinat Al Zahar (right), Umayyad<sup>(6)</sup>

The mihrab is the focus of religious symbolism in mosque architecture. Technically and theoretically, it could be a visual identification of the qibla wall. But popular belief shows it as a shrine for divine illumination and as the gate to Paradise.<sup>(10)</sup> In the Middle East, mihrabs are often semi-circular, while in Spain and Morocco, they are polygonal, often accentuated by a hanging dome over or in front of them.<sup>(11)</sup> From the early eighth century, mihrab has either a single or, less frequently, double or multiple niches.<sup>(12)</sup> In some places, Shiite mosques have double mihrabs.



Different types of mihrab<sup>(6)</sup>

Visibility, a principle in Islamic ornamentation, is generally focussed on the portal, mihrab, and maksura.<sup>(13)</sup> And Arabs 'almost' always insisted on adorning the columns of mihrab with capitals in style in conformity with their ornamentation.<sup>(14)</sup> Ways of enhancing mihrab varied, depending upon periods and places, and even the absence of ornamentation on it can make a visible distinction from its surrounding areas.<sup>(15)</sup> In adorning Javanese mihrabs, the same idea seems to be applied. However, mihrabs in Jakarta do not have much ornamentation, for fear of disturbing prayers' concentration on God.<sup>(16)</sup> By contrast, a beautiful mihrab is a strategy for encouraging non-Muslims to embrace Islam.<sup>(17)</sup>

Characteristically, in Java, the sacredness of mihrab was much underlined. Several great mosques have a chronogram (*candrasengkala*) within or above their mihrabs. Most mihrabs have a semi-circular vault and ornamentation, often with kala-makara. A kala head at the top in the centre with a symmetrical and scroll-like body flows down on either side and meets makara at each end. Sometimes floral motifs replace a visible kala-makara.

For instance, the mihrab in Agung Kasepuhan of Cirebon has elaborate decorations; a lotus flower suspended within the vault of the mihrab, and surya (sun), a symbol of the Hindu Majapahit kingdom in East Java, represent power and supremacy. As central motifs, the lotus and the sun

signify fundamental aspects of life - 'embodied immortal and religious duties (lotus flower), and the perfect attainment of spiritual insights towards victory in the afterlife (sun)'. Islam emphasises the Muslim duty in social and spiritual relationships, and without performing their duties, Muslim rights are not respected. In this context, the relationship between Islamic principles and the images of the lotus flower and the sun on the mihrab becomes clearer.<sup>(18)</sup>

Many mihrabs in Java were rebuilt during renovations, using new glazed ceramic tiles on the walls. Mihrab can have two or three arches, depending upon its size, but a traditional mosque usually has one simple mihrab. Compared with luxurious and elaborate mihrabs in other parts of the Islamic world, the simple design of Javanese mihrabs could be considered a characteristic. In several modern mosques, it has even been omitted, such as in Pondok Indah (1990) of Jakarta, the capital of Indonesia.<sup>⊗</sup>

---

<sup>⊗</sup> (1) Dickie 1978 (2) Irwin 1997 (3) Stierlin 1996 (4) Hillenbrand 1994 (5) Grabar edited by Hattstein 2000 (6) Wafi 1988 (7) Frishman 1994 (8) Irwin 1997 (9) Wafi 1988 (10) Hillenbrand 1994 (11) Davies 1982 (12) Insoll 1999 (13) Hillenbrand 2001a (14) Prisse 1983 (15) Behrens-Abouseif 1998 (16) Mansyur Sawah Lio 2003 interview (17) Prijotomo 2004 interview (18) Isnaeni 1996: (a) Marçais 1954 (b) Subarna 1982-3

## Part Two

The extraction of part two introduces four syncretic pre-Islamic ornaments and their analysis by using elements of design and its principles in Javanese mosque ornamentation.

### CONTINUITY OF PRE-ISLAMIC ORNAMENT

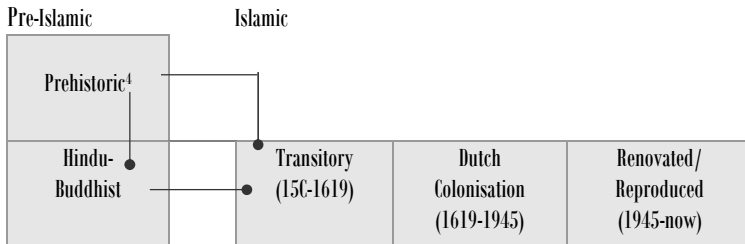

---

<sup>4</sup> The term, “prehistoric” means neolithic and megalithic times, when tumpals used in decoration.

# E L E M E N T S   &   P R I N C I P L E S   O F   D E S I G N

The researcher has an intention to apply elements and principles of design as indicators to the analysis of four pre-Islamic motifs (tumpal, kala-makara, lotus bud, scroll). First, they are the essential components in architecture, discussed by Greek, Roman, medieval, Renaissance and modern philosophers. In his *Grammar of Ornament*, Owen Jones (1856) puts forward geometry as general principles for decoration: 'All ornament should be based upon a geometrical construction', praising Alhambra palace built by the Moors.

... every ornament contains a grammar in itself. Every principle which we can derive from the study of the ornamental art of any other people is not only ever present here, but was by the Moors more universally and truly obeyed.<sup>(1)</sup>

Second, Islamic ornament is mostly composed of geometry, based on elements and principles of design. Critchlow (1989) argues a circle as a symbol of the 'origin' and 'end' of geometric forms. Islamic art is essentially a way of ennobling matter through geometric and floral patterns united by calligraphic forms which embody the word of God, as revealed in the sacred book, the Koran.<sup>(2)</sup> Last, the researcher is specialised in visual art and design; thus the indicators can provide comprehensive information with a challenge on research method. Ornament consists of elements (line, value, shape, form, space, texture, colour) of design and its principles (unity-variety, balance, emphasis, rhythm, proportion, size). Principles show how elements are aesthetically combined to arouse a sensory response.<sup>(3)</sup> Elements, the raw materials of works of design, are arranged to produce an order in the composition, supported by principles.<sup>(4)</sup> <sup>⊗</sup>

---

<sup>⊗</sup> (1) Jones 1856; 2001 (2) Critchlow 1989 (3) Holt 1989 (4) Brommer 1975

# TRANSCENDENCE OF PREHISTORIC TUMPAL (Case 1)

A tumpal, a decorated triangle, is a universal ornament in Java. It was originated in Neolithic and megalithic times in prehistoric Indonesia and continued in Hindu-Buddhist temples. Despite the uncertainty of its origin as a human figure or a stylised bamboo shoot, the motif used for a symbol, due to its magic character, or because it conveyed an idea of fertility.<sup>(1)</sup> It can represent the holy worship of the Cosmos Mountain, Meru, where gods reside.

Many types and variations of tumpal found during the fieldwork, but the main shape is triangular, facing either downwards or upwards. Another type, called “antefix”, is also present in temples, but since it combines a triangle and a rectangle, Tjandrasasmita (2005) recommends it as a variant of tumpal.<sup>(2)</sup> A common characteristic could be traced both in mystical, symbolic connotation and aesthetic, decorative beauty among tumpals. They appeared across time, scattered over the whole of Indonesia on fishing baskets, and in temples and mosques. They made of wood, stone, or other materials, and some richly decorated. The majority have both straight and curved lines, balanced in symmetry. After the Dutch colonisation of Java (1619), they are coloured with paint, or their material itself have colours. Based on these facts, megalithic tumpals on fishing baskets travelled to sacred Hindu-Buddhist temples and finally settled down in sacred Javanese mosques, underlining symbolism, rather than beauty.

Continuity of prehistoric tumpal in Javanese temples and mosques<sup>(a)</sup> (\*renovated in 200)



(Group 1) Prehistoric; Kalasan Buddhist temple (90); Agung Demak mosque (1479)\*

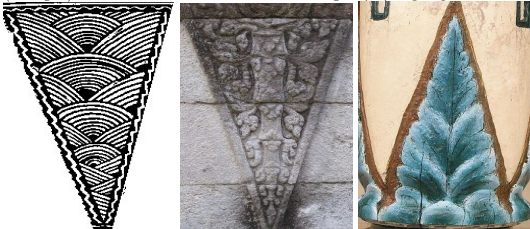

(Group 2) Prehistoric; Panataran Hindu temple (1147-1454); Agung Yogya mosque (1773)



## On Mihrabs

Javanese mihrab is the most significant place for symbolism and aesthetics. Mystical Sufis adopted the sacredness of pre-Islamic art traditions into their mosques, creating them sacred, and consequently, mihrab was not exceptional. Mihrab, as an indicator of the building's orientation towards Mecca, symbolises a gateway to Paradise. Moreover, since the religious leader leads the congregation in prayer, mihrab is richly embellished in general, although *Hadith* warns that luxurious decorations can disturb Muslim prayers. Ornamenting mihrabs is done in various ways, according to periods and places. Even the absence of ornaments can highly visualise their surroundings.

The commonness in Javanese mihrab ornamentation can attribute to *walis* (saints) who participated in constructing the earliest mosques, moving from area to area, in parallel with the spread of Islam. However, based on the number which appeared on mihrabs, tumpals were not much favoured. It also suggests that Javanese mihrabs are not luxurious but simple.

Two tumpals can illustrate mihrab ornamentation in Java. Both mosques bearing them belong to the transitory period. The tumpal of Merah Panjunan (Java West, 1430) is original, made of plaster, while that of Menara Kudus (Java Central, 1537) newly made, and coloured on glazed tile and glass. Chronologically different, Merah Panjunan has a diamond and is composed of natural lines. Menara Kudus shows a triangular combined of 10 rectangles with extremely geometrised lines. In appearance, no common feature can see, but the strong symbolic meaning of the Cosmos Mountain connects them. Despite their sacred concept, contrary to an expectation, tumpals not much used on mihrabs. Where they appeared, they were not decorated, probably due to their symbolism. It also indicates simple Javanese mosque ornamentation.

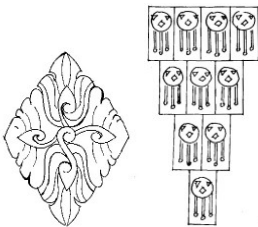

Merah Panjunan mosque; Menara Kudus mosque\*

## Line (Element)

Without a study of Greek, we could not know the meaning of great design, of harmonious lines and masses, of proportion and composition, of thoughtful correctness in figure-drawing, of the pleasant and proper disposition of the materials or motifs of an ornament.<sup>(3)</sup>

The line consists of an extended point, and its only feature is the length. It connects other visual elements, describes edges, formulates shapes, and articulates the surfaces of planes. Although the line has only one dimension theoretically, it has visible thickness. The character of the line, such as bold or tentative, graceful or ragged, is decided by human perception of its length-width proportion, its outline, and its degree of continuity.<sup>(4)</sup> The Line is a creation of the human sense of sight, constructed for simplicity, borrowing Delacroix's (1798-1863) idea of the straight line as 'never occurs in nature; they exist only in the brain of man'.<sup>(5)</sup>

Despite possessing no actual movement, a line suggests a direction, either one way or in diverse ways.<sup>(6)</sup> Lines may divide into straight or curved. A straight line defines as 'the shortest distance between two given points'. It can be vertical, horizontal or diagonal, and appears stronger and more direct than a curved line. A vertical line is structural, upward, and the strongest, and expresses a state of equilibrium with the force of gravity. A horizontal line represents stability on the ground plane. A diagonal line indicates action, due to its disturbing effect.<sup>(7)</sup> Horizontal lines create geometric shapes, whereas contour lines decide space, and repeated lines create texture.<sup>(8)</sup>

Of a curved line, Hogarth (1679-1764) introduces the aesthetic concept of his precise serpentine line as 'line of beauty'. He saw beautifying lines as the ideal sign of artistic craftsmanship.<sup>(9)</sup> In this context, Riegl (1893) argues that line was the primary tool of the artist, and decorative art was the application of line to solve ornamental problems. The term "beautiful" was bound up with the idea of organic undulating lines and with the art of classical Greece.<sup>(10)</sup> Logarithmic spirals enhance the dynamism of the curve.<sup>(11)</sup> Lines are associated with the ideas of praise, aspiration, and ascension. Vertical lines increase this feeling, but downward bent lines convey despair. As a language, a line is the most sensitive and vigorous speech for all purposes. The line is used as a vehicle to record nature and human features, appealing to human emotions and evoking sympathies with the life of nature and humanity.<sup>(12)</sup>

This upward surge of lines, characteristic of Gothic art, was an element of beauty which at the same time responded to a profoundly appealing feature of medieval mysticism.<sup>(13)</sup>

Basic type of line

Straight			Curved		
Vertical	Horizontal	Diagonal	Circular	Spiral	Undulating

Five further characteristics of line

Dichotomy	Description
Broken/Unbroken	If lines of tumpal do not connect with the starting point, and repeatedly stops, they are called 'broken'.
Natural/Geometrical	If lines of tumpal are not stylised or are not composed of circle, triangle, and square in composition, they are called 'natural'.
Inner/Outline	If lines of tumpal do not constitute a boundary, they are called 'inner'. Any lines within the frame treat as 'inner'.
Short/Long	If lines of tumpal are composed of short lines, they are called 'short'.
Simple/Complicated	If tumpals became stylised by line, they are called 'simple'.

**Straight/Curved**

Basic type of line can divide into straight and curved. Prehistoric and Kalasan temple have only straight or curved respectively, Agung Demak has both.

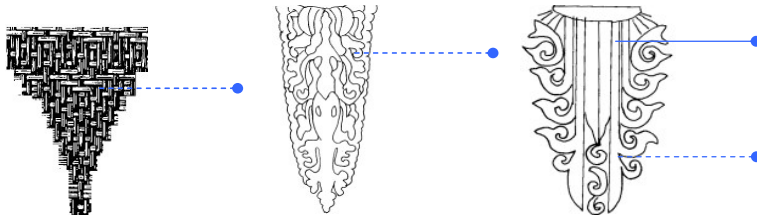

Prehistoric, straight; Kalasan Buddhist temple, curved; Agung Demak mosque, straight/curved

**Vertical/Horizontal/Diagonal of the Straight**

Straight lines can subdivide into vertical, horizontal, and diagonal. Prehistoric has horizontal and diagonal, East Javanese temple of all types, Agung Yogya mosque, horizontal/diagonal.

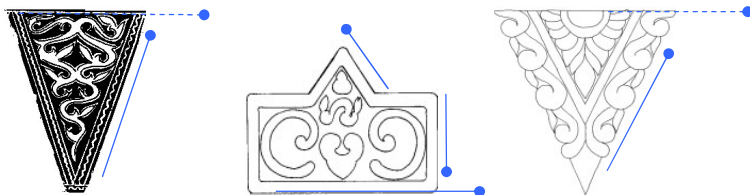

Prehistoric, horizontal/diagonal; East Javanese temple, vertical/horizontal/diagonal; Agung Yogya mosque, horizontal/diagonal

### Circular/Spiral/Undulating of the Curved

Curved lines can subdivide into circular, spiral, and undulating. Prehistoric has half circles inside the frame, Kalasan temple and Astana Mantingan with spiral and undulating.

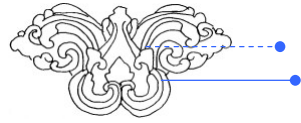

Prehistoric, circular; Kalasan Buddhist temple, spiral/undulating; Astana Mantingan mosque, spiral/undulating

### Other Element & Principle of Design

**Space** is the medium in which shapes exist. It has three characteristics of pictorial, illusionistic, and actual. Pictorial space is the outcome of artistic work. Illusionistic space creates a perceptual illusion through various devices, while actual space deals with three-dimensional work.<sup>(14)</sup>

narrow/wide <sup>⊗</sup> lines	if the space between adjacent lines is broad in tumpals, they are called 'wide'.
--------------------------------	--



narrow distance



narrow distance

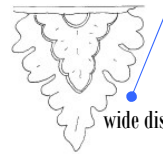

wide distance

Prehistoric; Panataran Hindu temple; Sunan Giri mosque<sup>⊗</sup>

**Emphasis** is created by visual importance through selective stress.<sup>(15)</sup> It involves dominance and subordination. Dominance is the effect of superior value against the subordination of something of secondary importance.<sup>(16)</sup> Reinforced through repetition, proportion, simplification, and contrast,<sup>(17)</sup> emphasis can also achieve by a group or the isolation of a feature.<sup>(18)</sup>

dominant/subordinate <sup>⊗</sup> lines	if lines are more important than other elements in a composition of tumpals, they are called 'dominant'.
---	--

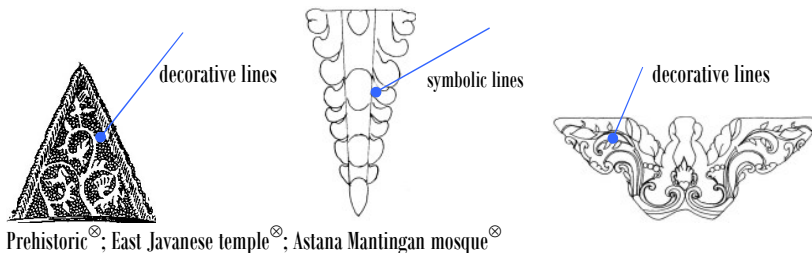

## Conclusion

Tumpals, born on fishing baskets of an anonymous fisher in prehistoric times, transcended to sacred sanctuaries under the auspices of Hindu-Buddhist gods and goddesses many centuries later. Another epoch later, they were sited in sacred Javanese mosques as one of the prestigious ornaments. If they had not represented the holy worship of the Cosmos Mountain where gods and goddesses reside, how could their destiny be so miraculously blessed? The indebtedness goes to Javanese Muslims who adore their cultural inheritance.<sup>⊗</sup>

---

<sup>⊗</sup> Prehistoric, Kalasan Buddhist temple (9C), Panataran Hindu temple (1147-1454), East Javanese temple (12-5C), Agung Demak mosque (1479), Merah Panjunan mosque (1480), Sunan Giri mosque (1485), Menara Kudus mosque (1537), Astana Mantingan mosque (1559), Agung Yogya mosque (1773)

(1) Wagner 1959 (2) Tjandrasasmita 2005 (3) Collingwood 1883 (4) Ching 1996 (5) Arnheim 1974 (6) Krommenhoek 1975 (7) Alexander 1965, Ching 1996 (8) Stoops 1983 (9) cited by Burke 1955 (10) Olin 1992 (11) Grillo 1960 (12) Crane 1900 (13) Aubert 1959 (14) Holt 1989 (15) Stoops 1983 (16) Alexander 1965 (17) Gatto 1975 (18) Holt 1989: (a) drawings-Pepin Press 1998; photo:Lee-Niinioja, 2004

## METAMORPHOSIS OF HINDU-BUDDHIST KALA-MAKARA (Case 2)

Kala-makaras frequently find in temples. With a human face or demon's head, kala appears over an arched gate of a temple, while a pair of curved makaras terminates outward at the bottom of a gatepost. A makara, an imaginary animal with the shape of a fish and the trunk of an elephant, was introduced during Hinduisation, the same as kala.<sup>(1)</sup> Nevertheless, Subarna (2005) insists on the existence of a similar form of kala in prehistoric times in Indonesia.<sup>(2)</sup>

Between Central and East Javanese kala, the former has no lower jaw, while the latter has a full face with a jaw. In Indian mythology, kala-makara represents the holy Cosmos Mountain, the abode of gods, and expels demonic influence from temples as a protector. Kala is a symbol of the celestial element, and makara is the watery element in creation. As combined, they form duality and totality.

Many types and variations of kala-makara found during the researcher's fieldwork, but the main shape is a simple rectangle or a combination of rectangles and triangles in temples, and ovals in mosques. Interestingly, their shapes changed in transfer from temples to mosques, often simplified, probably caused by the prohibition on depicting living figures, according to *Hadith*. Usually, on mihrabs, kala sits on the top of a curved arch, accompanying makaras on each side of the bottom, balanced in symmetry. One wonders, if they were not living animals, they could smoothly continue anywhere without conflict against Islamic art tradition. Shifting natural shapes of Hindu-Buddhist kala-makaras into geometric of Islamic ones was unavoidable.

Despite its stylisation, the commonness could trace between them both in mystical, symbolic connotation, and aesthetic, decorative beauty. Kala-makaras appeared all the time, spread in temples and mosques over the whole of Indonesia. They made of stone, wood, and other materials such as brick, plaster and tile, sometimes adorned with scrolls. Even, they likely coloured after Dutch colonisation.

Continuity of Hindu-Buddhist kala-makara in Javanese mosques (\*renovated in 200)





Group 1) Borobudur Buddhist temple (8C); Merah Panjunan mosque (1480); Caringin Labuan mosque (1883-93)



(Group 2) Borobudur Buddhist temple (8C); Central Javanese temple (8-9C); Raya Cipanganti mosque (1933)

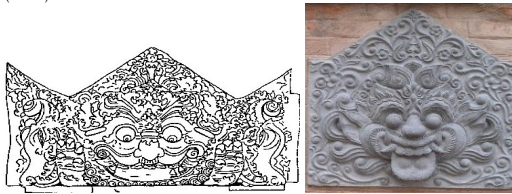

(Group 3) Prambanan Hindu temple (8-9C); Agung Mataram mosque (1568-1601)\*



(Group 4) Agung Demak mosque (1479); Al Anwar Angke mosque (1761); Al Wustho Mangkunegara mosque (1878-1918)

## On Mihrabs

Mihrabs mostly decorated according to Islamic art tradition. Kala-makaras more found in West Java, made of other materials with decoration. Oval shapes are preferred, and smooth and big ones fully used. Unified shapes of kala-makaras were not coloured. Ornamentation of kala-makaras on mihrabs did not differ from that in other locations in a mosque building.

Merah Panjunan mosque; Agung Kasepuhan; Sunan Kalijaga; Agung Mataram; Jami Kanoman; Al Wustho Mangkunegara; Kasunyatan\*; Sendang Duwur\*; Al Makmur Jipang\*; Kanari\*; Al Mansyur S. Lio\*; Carita Labuan\*

## Shape (Element)

The shape is the outline of a plane figure or the surface configuration of a form. It is the primary means of providing recognition, identification, and categorization for specific figures and forms. The perception of shape depends on the level of visual contrast between the outline which separates a figure from its ground.<sup>(3)</sup> Positive and negative shapes and their interrelationships are a principle of composition. Positive shapes are the subject matter itself, becoming the centre of interest, while negative shapes are the areas surrounding the positive shape.<sup>(4)</sup> Although the negative shape is not always of equal interest with the positive figure, it is important in providing an illusion of depth.

Shapes can form by lines, areas of texture, value, and colour. They vary from simple circles, triangles, and squares to complex silhouettes of nature and the human form. They have both two- and three-dimensional characters. Two-dimensional shapes border by lines and are perceived as a visual unit distinct from their background,<sup>(5)</sup> while three-dimensional ones can extend in any perceivable direction, creating forms.<sup>(6)</sup> Four categories of shape exist: (i) natural, (ii) geometric, (iii) abstract, and (iv) non-objective. Natural shapes originate from nature and human figures. Geometric shapes arise from man-made construction. Abstract shapes are the outcome of reducing natural ones by stylisation. Non-objective shapes do not originate from any recognisable source.<sup>(7)</sup>

According to the Gestalt psychology school, the mind makes the visual environment simpler to understand it. Given any composition of forms, the mind tends to reduce the image to the simplest and most regular shapes.<sup>(8)</sup> Originated in Germany in the early 20<sup>th</sup> century, the school has been most influential in the field of perception. It formulated four laws for establishing a visual field: (i) Proximity, (ii) Similarity, (iii) Continuance, and (iv) Closure.<sup>(9)</sup> Thus a shape is never perceived as the form of just one particular thing, but always like that of a kind of thing. The shape is a concept in two different ways: first because we see every shape as a kind of shape compared to what says about perceptual concepts; second, because each kind of shape sees as the form of a whole kind of objects.<sup>(10)</sup> Shapes can be basic emotional symbols with a powerful impact.<sup>(11)</sup> A clear, well-defined shapes, such as a cross or a key, can generate a universal appeal as a symbol.<sup>(12)</sup>

### Basic type of shape

Natural	Geometric				
	Circular	Oval	Triangular	Square	Rectangular

### Five further characteristics of shape

Dichotomy	Description
Dynamic/Static	If shapes of kala-makara show a movement in different directions, they are called 'dynamic'.
Single/Assorted	If shapes of kala-makara have different styles of shape, such as a circle, triangle,



	and rectangle, they are called 'assorted'.
Illustrating/ Abstract	If shapes of kala-makara are composed of natural lines and express a real image, they are called 'illustrating'.
Smooth/ Complicated	If shapes of kala-makara perceive as jagged and uneven, they are called 'complicated'.
Small/Big	If shapes of kala-makara made of a big and whole shape, they are called 'big'.

### Natural/Geometric

Basic type of shape can divide into natural and geometric. Defining 'natural' shapes are (i) living animal of kala-makara, and (ii) natural floral motif without stylisation. 'Geometric' stylised: (i) abstracted, such as a circle, oval, triangle, square, and rectangle, (ii) simplified shapes, and (iii) stylised spirals. Prambanan temple and Agung Kasepuhan have natural shapes, but Agung Mataram and Carita Labuan geometric.



Prambanan Hindu temple, natural; Agung Kasepuhan mosque, natural

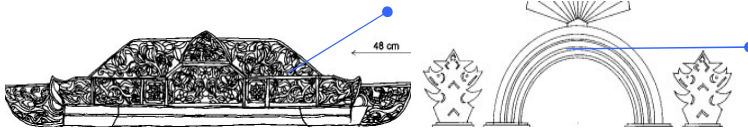

Agung Mataram mosque, geometrical; Carita Labuan mosque, geometrical

### Circular/Oval/Triangular/Square/Rectangular of the Geometric

Geometric shapes can be divided into circular/oval/triangular/square/rectangular. Circular includes circles, circular-like, and spirals, except curved which belong to oval shapes. A diamond is doubling triangles. Merah Panjunan has circular, Sunan Kalijaga oval, Sunan Kalijaga triangular, Al Anwar Angke square, and Agung Kasepuhan rectangular.

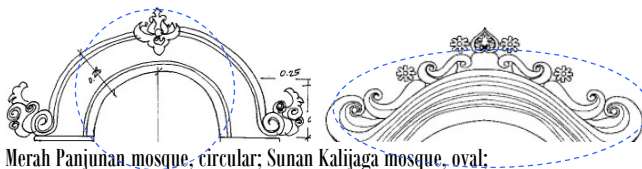

Merah Panjunan mosque, circular; Sunan Kalijaga mosque, oval;

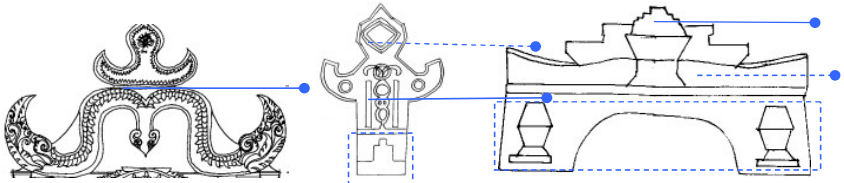

Sunan Kalijaga mosque, oval/triangular; Al Anwar Angke mosque, circular/triangular/square/ rectangular; Agung Kasepuhan mosque, triangular/rectangular

## Other Element & Principle of Design

**Colour** evokes the highest emotional response, suggesting a mood and depth of experience. It is both art and science. Physicists discuss abstract theories of colour about light and optical principles involved in colour sensation; chemists formulate rules for blending colours; psychologists preoccupy with emotional responses to colours.<sup>(13)</sup>

original/coloured <sup>⊗</sup> shapes	if kala-makaras are made of natural materials, and are neither coloured nor painted, they are called 'original'.
--	--



Agung Kasepuhan mosque; Jami Kanoman mosque<sup>⊗</sup>; Kanari mosque<sup>⊗</sup>

**Unity-Variety:** According to da Vinci (1452-1519), 'Every part is disposed to unite with the whole that it may thereby escape its incompleteness'. Each part should be essential itself and yet add to the total effect. Variety means different qualities through contrast. Unity and variety are interdependent in maintaining balance.<sup>(14)</sup>

separate/unified <sup>⊗</sup> shapes	if shapes of kala-makaras are not separated from each other, they are called 'unified'.
--------------------------------------	---

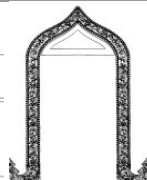
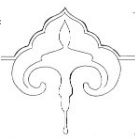

Borobudur Buddhist /Central Javanese temple; Raya Cipaganti mosque; Al Wustho Mangkunegara mosque<sup>⊗</sup>

## Conclusion

Kala-makara, one of the most significant pre-Islamic heritages, originated in India and was introduced to Java during the Hinduisation in the fifth century. They signified ultimately the sacredness of temples and mosques over time. Although their shapes became stylised in the metamorphosis from temples into mosques, losing their living figures to conform to orthodox Islam, Javanese Muslims' keen awareness of keeping the ancestor worship is apparent through a syncretic approach. Kala-makaras will reappear in mosques, regardless of any shapes. The important reason is their symbolic connotation as the holiness. <sup>⊗</sup>

---

<sup>⊗</sup> Borobudur Buddhist temple (80), Central Javanese temple (8-90), Prambanan Hindu temple (8-90), Agung Demak mosque (1479), Merah Panjunan mosque (1480), Agung Kasepuhan mosque (1498), Kasunyatan mosque (1522-70), Sunan Kalijaga mosque (1533), Sendang Duwur mosque (1561), Al Makmur Jipang mosque (1561-77), Agung Mataram mosque (1568-1601), Kanari mosque (1596-1651), Jami Kanoman mosque (1679), Al Mansyur Sawah Lio mosque (1717), Al Anwar Angke mosque (1761), Al Wustho Mangkunegara mosque (1878-1918), Caringin Labuan mosque (1883-93), Carita Labuan mosque (1889-95), Raya Cipaganti mosque (1933)

(1) van der Hoop 1949, Wagner 1959, Kempers 1959 (2) Subarna 2005 (3) Ching 1996 (4) Handell and Handell 1995 (5) Stoops 1983 (6) Arnheim 1974 (7) Holt 1989 (8) Ching 1996 (9) Thiel 1981 (10) Arnheim 1974 (11) Handell and Handell 1995 (12) Stoops 1983 (13) Holt 1989 (14) Alexander 1965

# IMAGINATION OF HINDU-BUDDHIST LOTUS BUD (Case 3)

Lotus played the most significant role in Hindu-Buddhist art. According to Hindu mythology, the creation of the world was represented by the growth of the sacred lotus. In Mahayanist Buddhism, lotus, as creator and supporter of the cosmic tree, is the pattern for the abstract notions of the Dharma. Its flower undergoes a series of metamorphoses, starting with a bud as an underlying symbolism.<sup>(1)</sup>

Among various types of lotus buds during the fieldwork, the main form is almost a regular sphere with the narrowest angle pointing upwards. Irregular ones also appeared. Either naturalistic or stylised or combined forms, a few common characteristics could be traced both in mystical, symbolic connotation and aesthetic, decorative beauty. They appeared all the time, spread over the whole of Indonesia, often accompanied by Hindu-Buddhist gods and goddesses in temples, and independently in mosques, particularly on sacred graves and mihrabs. Using different materials, they are sometimes coloured in gold and green to express the glory of the Islamic kingdom and religion respectively. Some embellished with kala-makara, scroll, and calligraphy. The majority of lotus buds tend to keep singular, balanced in symmetry to stress symbolism of life and unity. Proving these, lotus buds can be the most prominent motif in religious architecture.

Continuity of pre-Islamic lotus bud in Javanese mosque ornamentation (\*renovated in 200)



(Group 1) Kalasan Buddhist temple (9C); Sunan Giri mosque (1485); Al Alam Gilicing mosque (c.1520); Menar Kp. Melayu mosque (1820)



(Group 2) Sunan Giri mosque (1485); Kasunyatan mosque (1522-70); Kanari mosque (1596-1651)



(Group 3) Borobudur Buddhist temple (8C); Astana Mantingan mosque (1559); Tambora mosque (1761); Sabilliah Malang mosque (1974)



(Group 4) East Javanese temple (12-15C); Merah Panjunan mosque (1480); Agung Kasepuhan mosque (1498); Agung Yogya mosque (1773)

## On Mihrabs

Mihrabs are the most critical place for symbolic lotus bud whose appearance is the most common in West Java. They are made of wood and embellished with different motifs, stressing symbolism through beauty. Spherical mainly showed. 2-3 dimensional and dark were also predominant, and small and big equally used.

Pajlagrahan mosque; Agung Kasepuhan mosque; Langgar K. Kanoman mosque; Jami Kanoman mosque; Kampung Nembol mosque; Caringin Labuan mosque; Sunda Kelapa mosque; Sabilliah Malang mosque; Puskai Jaber mosque; Sunan Giri mosque\*; Al Makmur Jipang mosque\*; Al Mansyur S. Lio mosque\*

## Form (Element)

The Greeks seem to be the first people to have been delighted in the pure beauty of form, and consistently reached out after an ideal perfection of form.<sup>(2)</sup> A form is a perfect combination of all visual elements, themes, moods, techniques, functions, structure, and organization. The elements are balanced, and organized through the use of principles of design to establish harmonious unity in a form.<sup>(3)</sup> A form has several characteristics, either a recognisable appearance or a particular condition in which something manifests itself. In art and design, the term denotes the formal structure of a work. It is the manner of arranging and coordinating the elements to produce an image.<sup>(4)</sup> The form is the shape of an area of a three-dimensional volume, defined by the lines of its borders. Straight lines make shapes of triangles, squares, and pentagons. Triangles can be part of composing conic and pyramidal forms. On the other hand, curved lines make shapes of circles, ellipses and ovals. Circles create spherical forms. Forms can divide into natural and geometric forms, but no definite boundary can draw. The difference, however, is that natural forms are representational, while geometric forms are not. Natural forms are mostly of organic or living objects, such as foliage and humans, used in ornament both realistically and conventionalised. When a natural form is simplified to fit its use, it is called conventionalised or stylised.<sup>(5)</sup>

According to a theory of the 20<sup>th</sup> century, there are basic fundamental geometric forms: sphere, cube, cylinder, cone, and pyramid. They are solid and closed entities that show weight

and mass.<sup>(6)</sup> Primary forms are those whose parts are related to one another in a consistent and orderly manner - steady and symmetrical. Sphere, cylinder, cone, cube, and pyramid are regular forms. They can be perceived by (1) 3-dimensional, and (2) tend to be primary. Non-primary forms are those whose parts are dissimilar in their nature and related to one another in an inconsistent manner - asymmetrical and more dynamic than primary forms.<sup>(7)</sup>

Basic type of form

Primary					Non-primary
Cubic	Conic	Spherical	Cylindrical	Pyramidal	

Five further characteristics of form

Dichotomy	Description
Voluminous/Slender	If forms of lotus bud look massive and large, they are called 'voluminous'.
Open/Closed	If forms of lotus bud have open bulbs or are likely to be opened, or surrounded by lotus petals, they are called 'open'.
Realistic/Stylised	If forms of lotus bud constructed in a naturalistic way, they are called 'realistic'.
Dynamic/Static	If forms of lotus bud arouse actions, they are called 'dynamic'.
2-3 dimensional/ 3-dimensional	If forms of lotus bud are attached to other objects, such as walls and sculptures, they called '2-3 dimensional'.

Primary/Non-Primary

Basic type of form can be derived into primary and non-primary. Four examples are assessed to find primary/non-primary and their perfection. East Javanese temple and Agung Kasepuhan display primary, while Prambanan temple and Tambora non-primary.

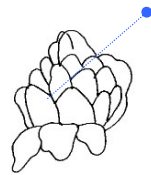
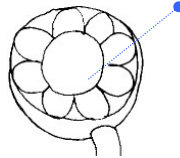
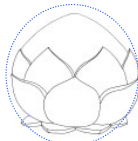

East Javanese Temple, primary; Agung Kasepuhan mosque, primary; Prambanan Hindu temple, non-primary; Tambora mosque, non-primary

Cubic/Conic/Spherical/Cylindrical/Pyramidal of the Primary

Primary forms can be subdivided into cubic/conic/spherical/cylindrical/ pyramidal. Sunan Kalijaga displays cubic, despite a bulbous form on the top. Kalasan temple and Al Alam Cilincing are conic, Prambanan temple and Al Marunda spherical, Central Javanese temple and Pajlagrahan cylindrical, East Javanese temple and Jami Al Islam pyramidal.

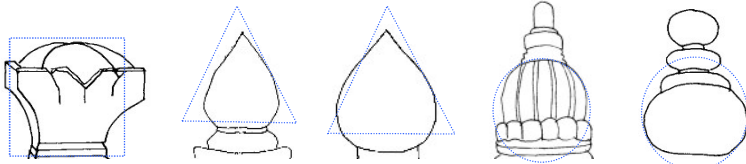

Sunan Kalijaga mosque, cubic; Kalasan Buddhist temple, conic; Al Alam Clinging mosque, conic; Prambanan Hindu temple, spherical; Al Marunda mosque, cylindrical

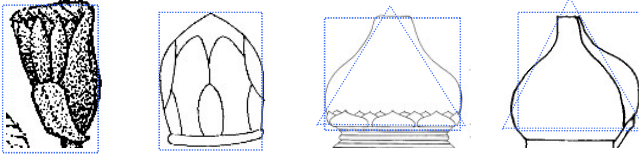

Central Javanese temple, pyramidal; Pajlagrahan mosque, pyramidal; East Javanese temple, cylindrical; Jami Al Islam mosque, spherical

### Other Element & Principle of Design

**Value** is the degree of lightness or darkness of an object.<sup>(9)</sup> Light values appear to expand and approach, while dark values appear to contract and recede, regardless of their size or shape.<sup>(9)</sup>

light/dark <sup>⊗</sup> forms	if lotus buds do not have layers; thus no darkness is created on their surfaces, they are called 'light'.
-------------------------------	---

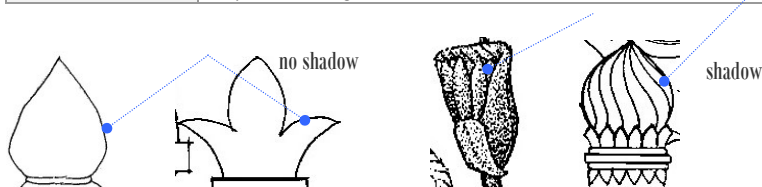

Kalasan Buddhist temple; Caringlin Labuan mosque<sup>⊗</sup>; Central Javanese temple; Langgar Kanoman mosque<sup>⊗</sup>

**Size** describes the relative scale of a given element about other elements and the composition as a whole. It perceives in many ways, as expressing symbolic meanings, attracting attention, and endowing dramatic emphasis. Big size means power.<sup>(10)</sup>

small/big <sup>⊗</sup> forms	if lotus buds are small in reality, they are called 'small'.
------------------------------	--

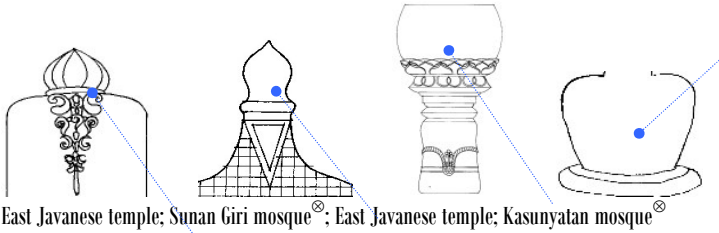

East Javanese temple; Sunan Giri mosque<sup>⊗</sup>; East Javanese temple; Kasunyatan mosque<sup>⊗</sup>

## Conclusion

Lotus bud, emerged from Egyptian and Indian civilisations in the ancient world, had an absolute reason to be the most potent ornament in Javanese temples and mosques, beyond time and space. It can represent ‘creation’ or ‘life’ in Hindu-Buddhism, and ‘oneness in Allah’ in Islam. It had a priceless prestige in imaginations of Hindu-Buddhist gods and goddesses. Allah and his people again prolonged this splendour. Lotus bud is the greatest mediator for Javanese syncretic ornamentation. Surely, Javanese Muslims knew the magic and holiness of a lotus bud, learned from their indebted ancestors.<sup>⊗</sup>

---

<sup>⊗</sup> Borobudur Buddhist temple (8C), Prambanan Hindu temple (8-9C), Central Javanese temple (8-9C), Kalasan Buddhist temple (9C), East Javanese temple (12-15C), Pajlagrahan mosque (1452), Merah Panjunan mosque (1480), Sunan Giri mosque (1485), Agung Kasepuhan mosque (1498), Langgar K. Kanoman mosque (1510), Al Alam Gilincing mosque (c.1520), Kasunyatan mosque (1522-70), Al Marunda mosque (1527), Sunan Kalijaga mosque (1533), Astana Mantingan mosque (1559), Kanari mosque (1596-1651), Al Makmur Jipang mosque (1561-77), Al Mansyur S. Lio mosque (1717), Jami Kanoman (1679), Tambora mosque (1761), Jami Al Islam mosque (1770), Agung Yogya mosque (1773), Menar Kp. Melayu mosque (1820), Kampung Nembol mosque (1880), Caringin Labuan mosque (1883-93), Sunda Kelapa mosque (1969-71), Sabilliah Malang mosque (1974), Pusdai Jaber mosque (1996)

(1) Seckel 1964, Bosch 1960, Zimmer 1960 (2) Hamlin 1916 (3) Stoops 1983 (4) Ching 1996 (5) Alexander 1965 (6) Stoops 1983 (7) Ching 1996 (8) Alexander 1965 (9) Handell & Handell 1995 (10) Holt 1989



# HARMONY OF HINDU - BUDDHIST SCROLL WITH ISLAMIC ARABESQUE (Case 4)

Hindu-Buddhist scrolls in Central Java have naturalistic and luxurious decoration, influenced from India. They run vertically in a narrow panel beside arched gates. Scrolls in East Java are simple and stylised, revealing an indigenous character. They undulate horizontally in a narrow frame or sometimes shape a medallion. Both scrolls occasionally combined with animals, humans, and circular objects.<sup>(1)</sup>

Scrolls in Javanese mosques are an amalgamation of Hindu-Buddhist and Islamic ideas and forms, created by the local genius. Accordingly, those in the Islamic transitory period have difficulty to be called 'scrolls', because different rhythms co-occur without repetition. If they followed geometrical arabesque, their rhythms could be easily traced, especially on arched mihrabs where vertical, horizontal, and diagonal rhythms occur. Whatever the case was, most scrolls have commonness both in symbolic connotation and aesthetic beauty. They appeared all the time, scattered over the whole of Indonesia in temples and mosques. They are made of different materials and sometimes are coloured. A few adorned with kala-makaras, Arabic calligraphy, etc.

Scrolls in temples and mosques are balanced in symmetry and undulate regularly, repetitively, and continuously. They tend to represent 'the start of life' ('the golden germ' by Bosch) in Hindu-Buddhism<sup>(2)</sup> and 'the vision of paradise' in Islam. Therefore, Islamic scrolls can be symbolic in syncretic Javanese mosques, although Islamic art is primarily decorative. The scroll is the universal motif in religious ornamentation.

Continuity of Hindu-Buddhist scroll in Javanese mosque ornamentation (\*renovated in 20C)



(Group 1) Borobudur Buddhist temple (8C); Al Wustho Mangkunegara mosque (1878-1918); Kalasan Buddhist temple (9C)



(Group 2) Cut Meutia mosque (1920); Sabilliah Malang mosque (1974); Hidayatullah mosque (1750)

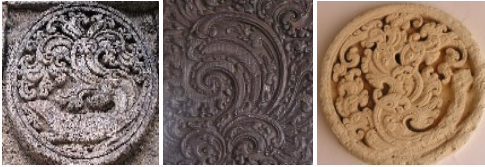

(Group 3) Panataran Hindu temple (1147-1454); Agung Demak mosque (1479); Astana Mantingan mosque (1559)



(Group 4) Kalasan Buddhist temple (9C); Agung Yogya mosque (1773); Sunda Kelapa mosque (1969-71)

## On Mihrabs

Scrolls on mihrabs mostly are located in Central Java. They made of wood without decoration. Scrolls favoured diagonal rhythms in particular. Additionally, continuous rhythms were the most common. Smooth and non-progressive were displayed.

Al Marunda mosque; Astana Mantingan; Agung Mataram; Agung Yogya; Mukarmah Bandan Agung Malang; Al Wustho Mangkunegara; Cut Meutia; Sabilliah Malang; Al Ukhawah Balai Kota; Agung Jepara

## Rhythm (Principle)

God is light, and light gives beauty to things; essential beauty must be identified with brightness which, together with harmony and rhythm, reflects the image of God.<sup>(3)</sup>

Those ineffable feelings of God's presence and purpose in His creation, that awareness of wholeness and infinitude, manifest in the natural world, and in those patterns and rhythms which govern it, are exemplified in iconic form in the art of calligraphy and illumination, as well as in the abstract disposition of mass, space and surface in architecture.<sup>(4)</sup>

The word "rhythm" in Greek means 'to flow'. Long before the Greeks, the rhythm was considered the creative principle, both in the manifestations of nature and in a regulated human life. In a world controlled by cruel gods, the Greeks invented a world of the mind, where the disaster expelled and a divine order ruled, demonstrated in the repeated columns in the Parthenon.<sup>(5)</sup>

Rhythm in design organizes a visual movement, built around repetitions of strong and weak design elements. As a means of conveying a feeling, rhythm has a variety of forms, such as sharp, jagged, jerky, irregular, radical, and energetic rhythms. Regular rhythm occurs when the repetition of size, shape, and colour remain the same with constant intervals. Irregular rhythm can add a suspense to a work, and increase its interest, caused by the varying size, colour, and shape of units.<sup>(6)</sup> Three ways of achieving rhythm are (i) through repetition, (ii) through a progression of design elements, and (iii) using a continuous basic line. Repetitive rhythm is the simplest rhythm, marked by a recurrence of patterns, while progressive rhythm requires an increase or decrease in shapes and is stronger than a repetitive rhythm. Continuous rhythm consists of curves, giving a flowing effect.<sup>(7)</sup>

Repetition is one of the most outstanding characteristics of form in nature, creating complex rhythmic passages of the pattern. Five kinds of repetition exist: (i) simple regularity of shapes and intervals, (ii) alternation: repetition of two different elements, (iii) inversion: repetition in which the position of a unit reverses, (iv) irregular recurrence: a chosen shape appearing at irregular intervals or with various sizes, (v) radiation: units fan out from a central point in symmetrical or asymmetrical array.<sup>(8)</sup>

**Basic type of rhythm**

Regular			Irregular
Vertical	Horizontal	Diagonal	

**Five further characteristics of rhythm**

Dichotomy	Description
Repetitive/ Non-repetitive	If rhythms of scroll repeat in the same way, they are called 'repetitive'.
Harmonious/ Disharmonious	If rhythms of scroll occur regularly in harmony, they are called 'harmonious'.
Single/Multiple	If scrolls have one rhythmic style, they are called 'single'.
Strong/Weak	If rhythms of scroll are dynamic, they are called 'strong'.
Continuous/ Discontinuous	If rhythms of scroll do not stop in a given area, they are called 'continuous'.

**Regular/Irregular**

Take any form you please, and repeat it at regular intervals, and you have, whether you want it or not, a pattern, as surely as the recurrence of sounds will produce rhythm or cadence. The distribution of the parts need not even be regular.<sup>(9)</sup>

Regular consist of consistency and repetition in the beat, while irregular occur inconstantly without repetition, lacking rhythms. In the design element, regular can perceive when scrolls undulate in circular, oval, and spiral in the same direction, based on a similar type of line and shape. Borobudur temple and Al Marunda have regular, while Panataran temple and Agung Demak display irregular.



Borobudur Buddhist temple, regular; Al Marunda mosque, regular

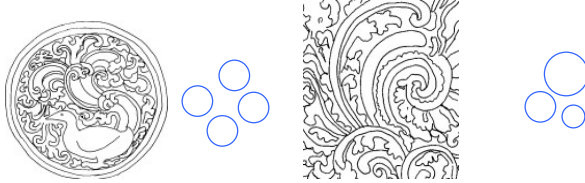

Panataran Hindu temple, irregular; Agung Demak mosque, irregular

### Vertical/Horizontal/Diagonal of the Regular

Regular rhythms can divide into vertical, horizontal, and diagonal. Hindu-Buddhist scrolls undulate vertically and horizontally. Central Java has upward rising scrolls or rectangular panels with scrolls. In East Java, motifs concentrate on horizontal bands. It was confirmed during the researcher's fieldwork too. Besides, the researcher often observed diagonal rhythms in temples and mosques, especially in contemporary mosques where Islamic arabesque has often been present. Kalasan temple and Agung Yogya have vertical; Panataran temple and Agung Yogya horizontal; and Kalasan temple and Caringin Labuan horizontal and diagonal.

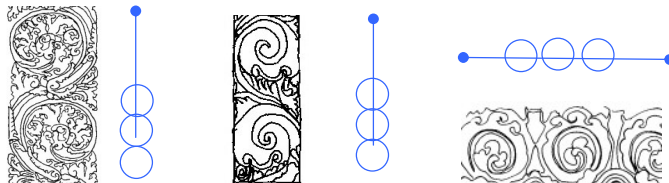

Kalasan Buddhist temple, vertical; Agung Yogya mosque, vertical; Panataran Hindu temple, horizontal

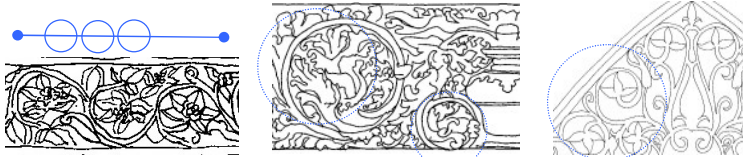

Agung Yogya mosque, horizontal; Kalasan Buddhist temple, horizontal/diagonal; Caringin Labuan mosque, horizontal/diagonal

## Other Element & Principle of Design

Texture refers to the surface of an object, natural or manufactured. It can be perceived in two different ways, visual and tactile. Tactile sensing happens through touch and connects to our experience.<sup>(10)</sup> Variations on smooth or uneven surfaces produce different visual textures.<sup>(11)</sup>

smooth/rough <sup>⊗</sup> rhythms	if scrolls undulate regularly, arousing evenness, they are called 'smooth'.
-----------------------------------	---

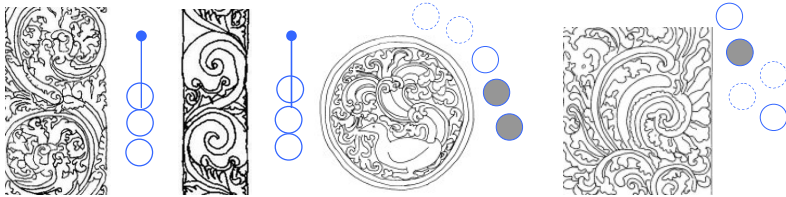

Kalasan Buddhist temple; Agung Yogya Mosque; Panataran Hindu temple<sup>⊗</sup>; Agung Demak mosque<sup>⊗</sup>

**Proportion** refers to the relationship of a shape to a total unit.<sup>(12)</sup> The Greeks' search for correct proportions is reflected in architecture by the creation of balance and harmony. Their geometric plan of the 'Golden Mean' established a canon of perfect proportion.<sup>(13)</sup>

progressive/non- progressive <sup>⊗</sup> rhythms	if the same type of rhythm recurs by the increase, they are called 'progressive'.
--	---

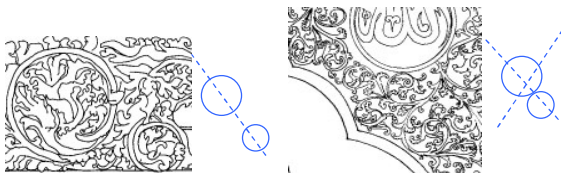



Kalasan Buddhist temple; Agung Jepara mosque; Mendut Buddhist temple<sup>⊗</sup>; Soko Tunggal mosque<sup>⊗</sup>

## Conclusion

When Hindu-Buddhist scrolls with animals in vast temples had to yield their freedom into small mosques, and change to lifeless shapes, due to *Hadith*, their identity can only be preserved in symbolism. ‘The start of life’ in Hindu-Buddhist scrolls had to encounter ‘the vision of paradise’ in Islamic arabesques to sanctify and beautify mosques, especially on mihrabs. Symbolic Hindu-Buddhist scrolls, confronting this task, did not surrender, instead invited Islamic arabesques to be symbolic in sacred Javanese mosques.

Consequently, geometric and mathematical Islamic arabesques had no choice of denying the invitation, due to Sufi Islam in Java. Their different principles in ornamentation became assimilated by tolerant and inventive local genius, despite the momentary chaos in their first meeting in ideas and forms. Soon after, Javanese Muslims brought back their heritage. Why? Because what they are looking for was the same Golden Fleece: ‘the start of life’ and ‘the vision of paradise’. Scrolls in Javanese temples and mosques are the most cosmopolitan motif, sharing the characteristics of repetitive, harmonious, and continuous rhythms with Islamic arabesques in common. ‘The Golden Germ’,<sup>(14)</sup> a key for Hindu-Buddhist scrolls, was still intact in Java.<sup>⊗</sup>

---

<sup>⊗</sup> Borobudur Buddhist temple (80), Kalasan Buddhist temple (90), Mendut Buddhist temple (90), Panataran Hindu temple (1147-1454), Agung Demak mosque (1479), Al Marunda mosque (1527), Astana Mantingan mosque (1559), Agung Jepara mosque (1561-77), Agung Mataram mosque (1568-1601), Hidayatullah mosque (1750), Agung Yogya mosque (1773), Mukarmah Bandan mosque (1789-1809), Agung Malang mosque (1853-90), Al W. Mangkunegara mosque (1878-1918), Caringin Labuan mosque (1883-93), Cut Meutia mosque (1920), Sunda Kelapa mosque (1969-71), Soko Tunggal mosque (1973), Sabilliah Malang mosque (1974), Al Ukhuwah Balai Kota mosque (1974)

(1) Kempers 1959 (2) Zimmer 1960, Bosch 1960 (3) Aubert 1959 (4) Yeomans 1999 (5) Holt 1989 (6) Brommer 1975 (7) Alexander 1965 (8) Stoops 1983 (9) Day 1903 (10) Stoops 1983, Ching 1996 (11) Holt 1989 (12) Alexander 1965 (13) Stoops 1983 (14) Bosch: Photos/Drawings: Lee-Niinioja 2004

## Part Three

The extraction of part three is an outcome of syncretic and orthodox Islamic ornament on 40 mihrabs by using the methodology, confirming a characteristic of Javanese Islamic architecture and ornament.

## J A V A : I N D O N E S I A

The huge Indonesian territory demonstrates a variety of cultural expressions, yet throughout history...The country has taken elements from each civilisation through their contacts abroad, but never adopted other cultures completely. Instead, Indonesians blended imported elements into existing circumstances, in order to create their own characteristic culture, with notable geographic variations. <sup>(1)</sup>

Indonesia, known as the Republic of Indonesia after gaining independence from colonial powers on the 17<sup>th</sup> of August in 1945, is situated in Southeast Asia in the Malay Archipelago. The fourth most populated country in the world, Indonesia comprises more than 13,000 islands extending 4,800 km along the equator from the Malaysian mainland and stretching towards Australia. The population is estimated at 220,000,000 on area about 1,900,000 sq km. Indonesia's main island groups are the Greater Sunda Islands (Java, Sumatra, Kalimantan, Sulawesi), the Lesser Sunda Islands (Bali, Flores, Sumba, Lombok, West Timor), the Moluccas, and the Riau Archipelago. Papua, part of the island of New Guinea, was integrated into Indonesia in 1969.

Its ethnic structure falls broadly into two groups, the Malayan and the Papuan, with many subdivisions owing to numerous immigration many centuries ago, mainly from Asia. Chinese constitute the majority of the non-indigenous population, and minorities of Arabs and Indians exist. Among more than 300 languages, Bahasa Indonesia has adopted as the official language. Today, almost 90% of the population is Muslim, making Indonesia the largest Islamic nation in the world. Around 7% of the population are Christian, and about 2% Hindu and 1% Buddhist. The major islands, culturally and economically, are Java, Bali, and Sumatra. Java is 1,200 km long and 500 km wide, situated about 7° south of the equator on the southern border of the Indonesian Archipelago with uninterrupted sequences of extinct and active volcanoes. The tropical climate, plentiful rainfall, and fertile soils provide for abundant agriculture.

Indonesia has a long history, starting from the 3<sup>rd</sup> millennium B.C. of Neolithic times, characterised by the advent of village settlements, domesticated animals, polished stone tools, pottery and food cultivation. Seafaring demonstrated as a major occupation by stylised boat motifs, depicted on ceramics, houses, sacred textiles of primitive tribes, and in bronze reliefs. At the end of the Neolithic period, megaliths were constructed, leaving many places of worship or tombs. No

definite date can be given, but are known to be less than 2,000 years old. The Chinese-influenced Dong Son Bronze-Iron culture of northern Vietnam started in the first millennium B.C. in Southeast Asia. All early Indonesian bronzes known to date are clearly of the Dong Son type, probably dated from between 500 B.C. and 500 A.D. Dong Son culture created fine ceremonial bronze drums and axes which decorated with engraved geometric, animal, and human motifs. It was highly influential in Indonesian art and culture.



Indonesia came under the influence of Indian civilisation mainly through trade and Buddhist missionaries already in the fifth century, but it was in the eighth century that the Sanjaya and Sailendra kingdoms were founded in Central Java, erecting Hindu and Buddhist temples such as Prambanan and Borobudur respectively, while Sumatra ruled by Sriwijaya kingdom. Around 930, political power shifted to East Java, and the Hindu kingdoms of Singasari and Majapahit arose, covering vast areas of the Malay Peninsula. Especially under Majapahit in the middle of the 14<sup>th</sup> century, the country experienced the most golden period of the whole Indonesian history, and the temple complex of Panataran testifies to its magnificence.

Despite the earlier arrival of Muslim traders in the 11<sup>th</sup> century (1082), a gradual penetration of Islam began, and by the end of the 16<sup>th</sup> century, Islam replaced Hinduism and Buddhism as the dominant religion. The first Islamic kingdom of Demak was established on the coastline (*pasisir*) in northern Java after the conquest over Majapahit, and many foreign Muslim traders settled down in harbour cities. During the second half of the 16<sup>th</sup> century, the political power shifted to Central Java where the Mataram kingdom was founded. Mataram was Islamic, but patterned itself after the great Hindu Majapahit, and practised mystic animism, Hindu-Buddhism, European pomp, and Islamic circumstance.

European influences in the Malay Peninsula came with the arrival of the Portuguese, who captured Malacca in 1511 in pursuit of spice and established trading posts. The Dutch (1596) expelled the Portuguese and opened the United Dutch East Indies Company (VOC) in 1602. Becoming the leading power in Indonesia by the 17<sup>th</sup> century, the Dutch built Batavia (now Jakarta) as the capital of the colony, and two centuries later, controlled the whole area, although a break



(1811-18) took place when the islands were ruled by the British as a result of a victory over Napoleon in a war (1811-14). The independence movement began early in the 20<sup>th</sup> century, and the formation in 1908 of Budi Utomo (High Endeavour) is often considered the start of organized nationalism. The Indonesian Nationalist Party (PNI) was set up under the leadership of Sukarno in 1927, and after a short occupation by the Japanese during the Second World War, Sukarno, as President, proclaimed an independent republic in 1945.<sup>(2)</sup> <sup>⊗</sup>

## Java West

**Jakarta:** According to *Suma Oriental* (1513) written by Tomé Pires, a Portuguese apothecary, and the story of Parahyangan, in the sixth century, the region of Jakarta was a vital harbour of Hindu Pajajaran kingdom in Sunda Kelapa. Not for long, the city captured by the army of the first Islamic Demak kingdom and Cirebon in 1524, then Banten led by Fatahillah. The conqueror changed the name of Sunda Kelapa to Jayakarta (“Conqueror”) on 22 June 1527. Within less than a century, the Dutch VOC commanded the city as their primary commercial base and changed its name to Batavia (30 May 1619). When the power of VOC was over in 1800, Batavia was the capital of Hindu Belanda. Under imperial Japan (1942-45), the name changed again to Jakarta. As the place for the proclamation of independence, the city has been the capital of the country since then. **Banten** was a part of Hindu Pajajaran, but became under the control of Islamic Kasultanan, ruled by Sultan Maulana Hasanuddin after the union of Cirebon and Banten (1552). The area was an important harbour for Muslim traders when the Portuguese took control over Malaka in 1511. Banten was the most powerful during Sultan Agung (1651-83), but began to decline after a war with VOC in Batavia (1684), and collapsed under the Dutch-Indies government (1823).

**Cirebon** is a harbour city on the north coast of West Java. The city keeps a long tradition of contacts, not only with old kingdoms of West Java (Pajajaran), Central (Mataram) and East Java (Majapahit) but also with the outside trading world. The cultural expression has reflected these contacts in language, literature, puppet theatre, artefacts such as textiles, pavilions and royal gardens with a Chinese flavour. Although Hinduism prevailed in the city, due to its part of Hindu Pajajaran, Islam penetrated through the business from Persia, Arabia, Gujarat and Bengal in India. Moreover, Malaya converted the new religious system in the city. Cirebon marked for Sunan Gunung Jati who had an active political and religious life as one of the spiritual leaders (Wali Songo) during the late 15<sup>th</sup> and 16<sup>th</sup> centuries. The city was founded by a prince of Pajajaran, Pangeran Cakrabuana, and succeeded by Sunan Gunung Jati, his son-in-law.

---

<sup>⊗</sup> (1) Pepin Press 1980 (2) Rutherford 1996, Koentjaraningrat 1990

## Java Central

Demak is located in the north of Central Java and was a historic port in the 15<sup>th</sup> century. As the centre of the Islamic kingdom, Demak marked the significant influence of the new religion throughout the island. As the economy of the kingdom based on trade, the transport and distribution of commercial goods for both domestic and overseas was crucial. Prince Patah founded Demak in 1500, and during Sultan Trenggono's (1521-46) rule, the city developed a politic power and defeated Hindu Majapahit, opening the first Islamic kingdom. After his death, Demak divided in Pajang and Demak. At the end of the 16<sup>th</sup> century, the power of the Islamic kingdom moved from the north coast to the inland (Demak to Mataram via Pajang).

**Kudus** is located near Demak, and had a political power until the end of the 16<sup>th</sup> century when Mataram controlled this area. Sunan Kudus gave the name "Kudus" after his pilgrimage to Al-Quds (the Holy City: Jerusalem). The city became an Islamic holy city for the spread of Islam in Java with teachings by Sunan Kudus as one of the nine Wali Songo. **Jepara** is a small port near Demak, located between two other vital ports: Cirebon to the west and Gresik to the east. The port was the starting point for traders who embarked to other parts of the Indonesian archipelago. It was a centre of the coast (*pasisir*) culture, bearing strong influences on decorative elements from China. **Yogyakarta**: In the sixth century, the Jogja region and neighbourhood was still in the forest, and played as an entry to Pajang kingdom which gave the name of Kotagede/Mataram. This region grew to be Islamic Mataram (1586) when Panembahan Senopati (1675-81) defeated Pajang. Mataram kingdom was in her zenith during Sultan Agung (1613-45), conquering all except Banten and Batavia. He moved the capital to Plered, but after his death, the capital was transferred from Kerta to Kertasura, further to Surakarta finally. The Jogja region divided into two kingdoms (Surakarta and Yogyakarta) after Giyanti agreement (1775).

## Java East

**Malang** began in the 14<sup>th</sup> century. A castle, named "Kutabedah", on the border of Brantas River was under the control of Demak, then Untung Suropati, and Mataram kingdom. Between 1767 and 1916, the Dutch controlled Malang, making it as a centre for East Java, due to its strategic location in the plantation area with cool weather, and accessible transportation by road and train. **Surabaya** was an important harbour from Hindu Majapahit in the 13<sup>th</sup> and 14<sup>th</sup> centuries. Traders from China, India and Arab visited this area even in the 12<sup>th</sup> century. Probably for that reason, Sunan Ampel chose this region for Islamisation in Java. The location near Trowulan (now, Mojokerto), the capital of Majapahit, made this area famous too. When Majapahit was declining, Gresik region and Surabaya city became less active but gave attention to Mataram (1625) and the Dutch as a resistance post for strategy. The town was the embarking place for pilgrimage to Mecca, as the second biggest city in the whole of Indonesia.

# T H R E E P E R I O D S

## **The Transitory Period (15C-1619)**

1 Gala Bayat, Klaten, JC (ca. 1400); 2 Pajlagrahan, Cirebon, JW (1452); 3 Agung Demak, Demak, JC (1479); 4 Merah Panjunan, Cirebon, JW (1480); 5 Sunan Giri, Gresik, JE (1485); 6 Agung Kasepuhan, Cirebon, JW (1498); 7 Langgar Kraton Kanoman, Cirebon, JW (1510); 8 Al Alam Cilincing, Jakarta, JW (c.1520); 9 Hidayatullah, Jakarta, JW (1750); 10 Kasunyatan, Banten, JW (1522-70); 11 Al-Alam Marunda, Jakarta, JW (1527); 12 Sunan Kalijaga, Demak, JC (1533); 13 Menara Kudus, Kudus, JC (1537); 14 Agung Jepara, Jepara, JC (1549); 15 Astana Mantingan, Jepara, JC (1559); 16 Sendang Duwur, Paciran, JE (1561); 17 Al Makmur Jipang, Jepara, JC (1561-77); 18 Agung Mataram, Yogyakarta, JC (1568-1601); 19 Kauman Semarang, Semarang, JC (1575); 20. Kanari, Banten, JW (1596-1651)

⊗ JC (JAVA CENTRAL), JW (JAVA WEST), JE (JAVA EAST)

## **The Dutch Colonisation Era (1619-1945)**

21 Jami Kanoman, Cirebon, JW (1679); 22 Al-Mansyur Sawah Lio, Jakarta, JW (1717); 23 Agung Surakarta, Solo, JC (1757); 24 Al Anwar Angke, Jakarta, JW (1761); 25 Agung Yogya, Yogyakarta, JC (1773); 26 Menara Kampung Melayu, Semarang, JC (c.1820); 27 Jami Robayan, Jepara, JC (1850); 28 Agung Malang, Malang, JE (1853-90); 29 Al Wustho Mangkunegara, Solo, JC (1878-1918); 30 Kampung Nembol, Banten, JW (1880); 31 Caringin Labuan, Banten, JW (1883-93); 32 Carita Labuan, Banten, JW (1889-95); 33 Cut Meutia, Jakarta, JW (1920); 34 Raya Cipaganti, Bandung, JW (1933)

## **The Contemporary Period (1945-to the present)**

35 Al Azhar, Jakarta, JW (1952-8); 36 Sunda Kelapa, Jakarta, JW (1969-71); 37 Sabilliah Malang, Malang, JE (1974); 38 Al Ukhuwah Balai Kota, Bandung, JW (1990); 39 Al Akbar Surabaya, Surabaya, JE (1995-2000); 40 PUSDai, Bandung, JW (1996)

# 4 0 J A V A N E S E M O S Q U E M I H R A B S

## CODES

Pre-Islamic motifs: tumpal (T), kala-makara (KM), lotus bud (L), scroll (S); Orthodox Islamic motifs: arabesque (A), geometry (G), calligraphy (C).

Material (M), Decoration (D), Indicator (I), Other element of design (E), Other principle of design (P), Characteristic (Ch)

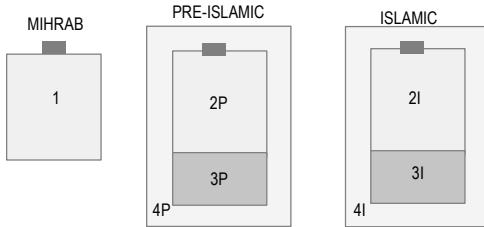

1 (mihrab except for prayer hall, 1P: pre-Islamic motifs, 1I: Islamic motifs).

2 (prayer hall, 2P: pre-Islamic motifs, 2I: Islamic motifs).

3 (serambi, 3P: pre-Islamic motifs, 3I: Islamic motifs).

4 (outside the mosque, 4P: pre-Islamic motifs, 4I: Islamic motifs).

## 1. Gala Bayat, Java Central (c. 1400)



Location: Paseban village, sub-district of Bayat, district of Klaten.

Founder: Ki Ageng Pandan Arang II (Sunan Tembayat).

The location of the mosque on a valley hill is unique. It is a simple building with a two-piled roof and sokoguru, exposing the traditional Javanese style. The name of Gala took from the words of “ga” (“one”) and “la” (“seven”). Together, it means ‘17’ rakaat prays. The mosque initially built on the Jabalkat hill and its sound callings were higher than those of Agung Demak; thus Sultan Demak tried to remove it. The mosque used for a pilgrimage or a passer-by. Pre-Islamic motifs outside the mosque indicate the influence of the Hindu-Buddhist period.

CODES: MAKARA, LOTUS BUD, SCROLL(3P); TUMPAL, KALA-MAKARA, LOTUS BUD(4P)

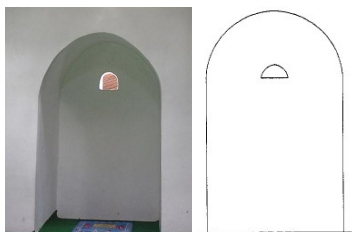

Mihrab (1.700 x 1000 cm)

## 2. Pajlagrahan, Cirebon, West Java (1452)



Location: Kasepuhan village, sub-district of Lemah Wungkuk, Cirebon.

Founder: Prince Cakrabuana (Walangsungsang).

The name of the mosque derives from the words of “Jala” and “graham” (air/water and a place for the water). It has a two-piled tajug roof and a mustaka. The building was much changed. The top of sokoguru cut; instead, concrete pedestals allowed a higher ceiling. An extra serambi (veranda) made because the original mihrab is too small to accommodate many people. Simplified lotus buds placed on the classical Greek-inspired columns.

CODES: LOTUS BUD(1P); TUMPAL, KALA-MAKARA, LOTUS BUD(2P); CALLIGRAPHY(2I); TUMPAL, SCROLL(3P)

L1. M (plaster), D (not decorated)	
I: Form	Primary (spherical: voluminous, open, stylised, static, 3-dimensional)
E: Value (light), P: Size (small)	

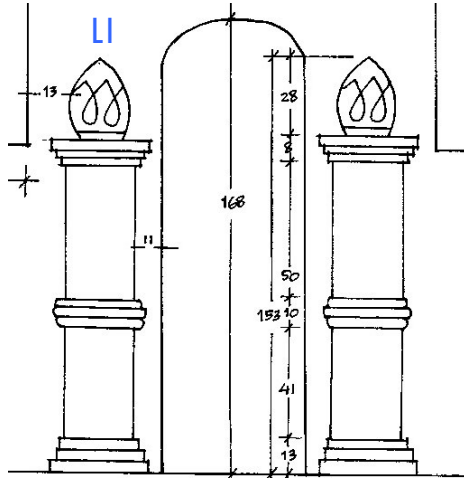

Mihrab (2000 x 1330 cm)

### 3. Agung Demak, Demak, Central Java (1479)



Location: Kauman village, sub-district of Demak, Demak. Founder: Wali Songo and Patah palace. Architect: Prince Sephet and Prince Trepas from Hindu Majapahit.

The mosque signals the resurgence of Islam as a political and social force. It is rectangular with a three-piled-roof, representing Faith (Imam), Submission (Islam), and Charity (Ihsan). The 28 pillars of the mosque took from the Hindu Majapahit kingdom during Sultan Demak II's rule. The prayer hall has sokoguru of teakwood built by Sunan Bonang, Sunan Gunung Jati, Sunan Ngampel, and Sunan Kalijaga. The mosque is rich in ornament, the sun, Chinese plate, floral of peony and lotus, animal (kala-makara, bird, dog, turtle, dragon), trophy, crown, and tumpal. The mihrab is made of pale yellow tiles with decorative borders and a medallion set into it. At its rear, the abstracted image of a turtle forms the *candrasengkala* (chronogram of Saka calendar). A ceramic medallion above the mihrab has a radiating sun, reminiscent of the *surya* Majapahit motif, glorifying the first Islamic kingdom.

CODES: GEOMETRY, CALLIGRAPHY(11), LOTUS BUD, SCROLL(2P); GEOMETRY, CALLIGRAPHY(2I); TUMPAL, SCROLL(3P); CALLIGRAPHY(3I); TUMPAL, KALA-MAKARA, LOTUS BUD(4P); CALLIGRAPHY(4I)

G1. M (wood), D (decorated with calligraphy), Ch (abstract, geometric, linear, mystical, repetitive, symmetric)

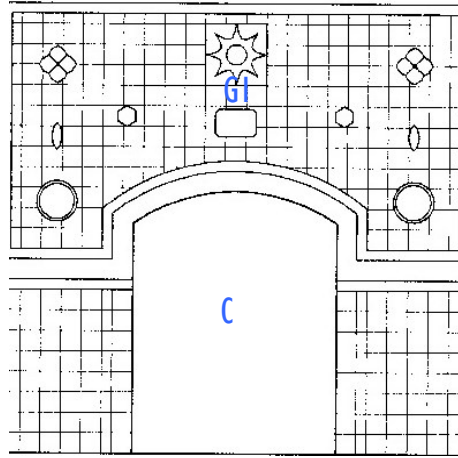

Mihrab (3280 x 3750 cm)

#### 4. Merah Panjunan, Cirebon, West Java (1480)



Location: Panjunan village, sub-district of Lemah Wungkuk, Cirebon.

Founder: Syarif Abdurrahman Al-Baghdadi,

The mosque bears the pre-Islamic Mataram style: a courtyard surrounded by a Hindu candi bentar. Ordinary praying does in a new-built serambi. Abdulrahman, an Iraqi Muslim leader, built the mosque. The word of Panjunan was originated from “anjun” (ceramic), as Panjunan is renowned for its local ceramic industry. The district name also likely derives from the name of an Iraqi prince, Pangeran Panjuan. The red brick walls made its name ‘the red mosque’ which was a place for Islam teaching and a meeting place for Wali Songo. The mihrab has decorative pilasters with small projecting floriated wings on either side.

CODES: TUMPAL, KALA-MAKARA(1P); TUMPAL, KALA-MAKARA, LOTUS BUD(2P); KALA-MAKARA, LOTUS BUD(3P); CALLIGRAPHY(3I)

T1. M (plaster), D (not decorated)	
I: Line	Curved (spiral, undulating: broken/unbroken, natural, inner, short/big, simple/complicate)
E: Space (narrow), P: Emphasis (dominant)	
KM2. M (plaster), D (decorated with tumpal)	
I: Shape	Geometric (circular, oval: dynamic, assorted, abstract, smooth/complicated, small/big)
E: Colour (original), P: Unity-variety (unified)	

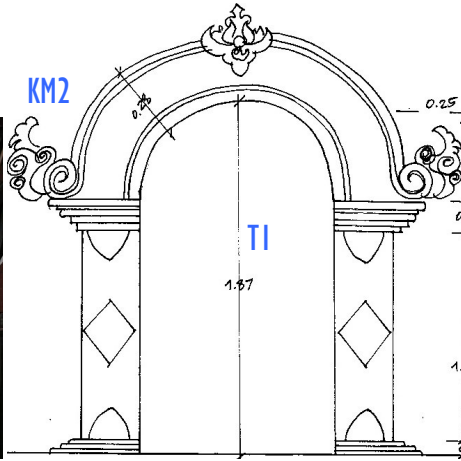

Mihrab (2150 x 1500 cm)

## 5. Sunan Giri, Gresik, East Java (1485)



Location: Subvillage of Sunan Giri, sub-district of Kebomas, Gresik.

Founder: Sunan Giri.

The mosque built on the summit of a steep hill, now called 'Bukit Giri', in the same precinct of the saint's tomb. Several renovations do not reflect the original feature any more. The prayer hall is rectangular with a three-piled tajug roof. In the front, there is serambi with wudhu, a washing pool. The mosque has rich ornaments; ceramics written in Arabic calligraphy mentioning the names of the Prophet, and floral images over the supporting pillars. Sunan Giri made the minbar, and a sun motif symbolises the great Hindu Majapahit. An unusual arrangement of the mihrab consists of two niches with dark red and brown glazed tiles. On the left is used as the mihrab, crowned by a pointed ogee arch with the undercoated finish. At its top, a red lotus indicates its pre-Islamic origin.

CODES: TUMPAL, KALA-MAKARA, LOTUS BUD(1P); TUMPAL, KALA-MAKARA, LOTUS BUD, SCROLL(2P); CALLIGRAPHY(2I); SCROLL(3P); CALLIGRAPHY(4I)

T1. M (wood), D (decorated with kala-makara, lotus bud)	
I: Line	Straight (horizontal, diagonal: unbroken, geometrical, outline, short, simple)
E: Space (wide), P: Emphasis (subordinate)	
KM2. M (tile), D (decorated with tumpal, lotus bud)	
I: Shape	Geometric (oval: static, single, abstract, smooth, big)
E: Colour (brown), P: Unity-variety (unified)	



L3. M (wood), D (decorated with tumpal, kala-makara)	
I: Form	Primary (conic: slender, closed, stylised, static, 2-3 dimensional)
E: Value (light), P: Size (small)	

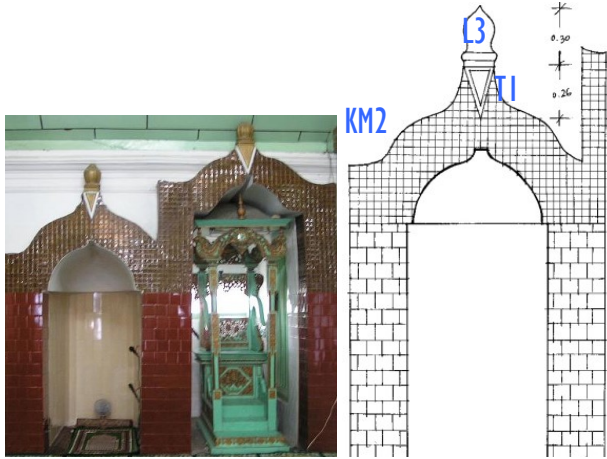

Mihrab (2780 x 1610 cm)

### 6. Agung Kasepuhan/Sang Ciptaras, Cirebon, West Java (1498)



Location: Kasepuhan Palace, sub-district of Lemah Wungkuk, Cirebon.

Founder: Wali Songo and Sunan Gunung Jati. Architect: Sunan Kalijaga, Prince Sephet & Prince Trepas from Majapahit.

The original size of the mosque was 350 m<sup>2</sup> with moulded brick walls. Leafy carvings in a spiral fill the entire front wall. Nine small entrances to the prayer hall are characteristic; the biggest is made of teak designed by Sunan Gunnung Jati, while Sunan Kalijaga did the symbolic kala-makara. The west qibla wall has a recessed mihrab which is vaulted in stone. Its opening superimposes with elaborately carved arch and a surya Majapahit on the centre. The floor of the mihrab incorporates three flagstones, placed by three walis (Sunan Bonang, Sunan Gunnung Jati, and Sunan Kalijaga), symbolizing Imam (faith), Islam (submission), and Ihsan (charity, good deeds).

CODES: KALA-MAKARA, LOTUS BUD(1P); GEOMETRY, CALLIGRAPHY(1I); KALA-MAKARA, LOTUS BUD, SCROLL(2P); GEOMETRY, CALLIGRAPHY(2I); TUMPAL(3P)

KM1. M (stone), D (decorated with lotus bud, geometry)	
I: Shape	Natural (dynamic, assorted, illustrating, smooth/complicated, small/big)
E: Colour (original), P: Unity-variety (separate)	

L2. M (stone), D (decorated with kala-makara, geometry)
I: Form Primary (spherical: voluminous, open, realistic, dynamic, 2-3 dimensional)
E: Value (dark), P: Size (big)
G3. M (stone), D (decorated with kala-makara, lotus bud), Ch (circular, geometric, mystical, rhythmic, symmetric)

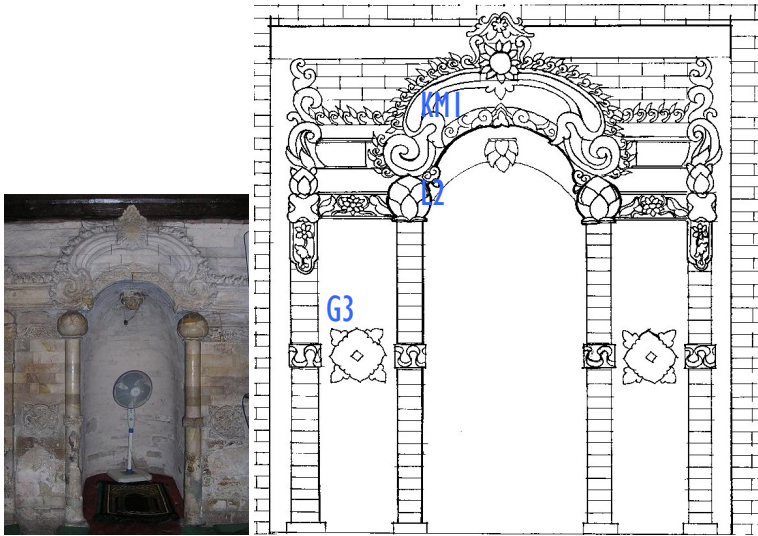

Mihrab (3000 x 2020 cm)

## 7. Langgar Kraton Kanoman, Cirebon, West Java (1510)



Location: Kanoman Palace, Cirebon. Founder: Maulana Hasannuddin.

The mosque is located in the west side of Kanoman Palace. It has the one-piled tajug roof with sokoguru, while the colonial influence sees in a white pool from the east serambi. The mosque has a Hindu paduraksa gate and Chinese ceramics on its wall to chase the evil spirit. The foundation of the mosque can be the same time as the palace (1510) by Prince Maulana Hasannuddin, Sunan Gunung Jati's son, before his trip to Banten to be a leader there. The mihrab has a golden arch, embellished with kala-makara, signifying the Islamic Kanoman kingdom.

CODES: KALA-MAKARA, LOTUS BUD(1P); CALLIGRAPHY(1I); TUMPAL, KALA-MAKARA, LOTUS BUD(2P); CALLIGRAPHY(2I)

KMI. M (wood), D (decorated with lotus bud, calligraphy)
--

I: Shape	Geometric (dynamic, assorted, illustrating, complicated, big)
E: Colour (coloured), P: Unity-variety (unified)	
L2. M (wood), D (decorated with kala-makara, calligraphy)	
I: Form	Primary (spherical: voluminous, closed, stylised, dynamic, 2-3 dimensional)
E: Value (dark), P: Size (big)	
C3. M (wood), D (decorated with kala-makara, lotus bud), Ch (curved, geometric, mathematical, mystical)	

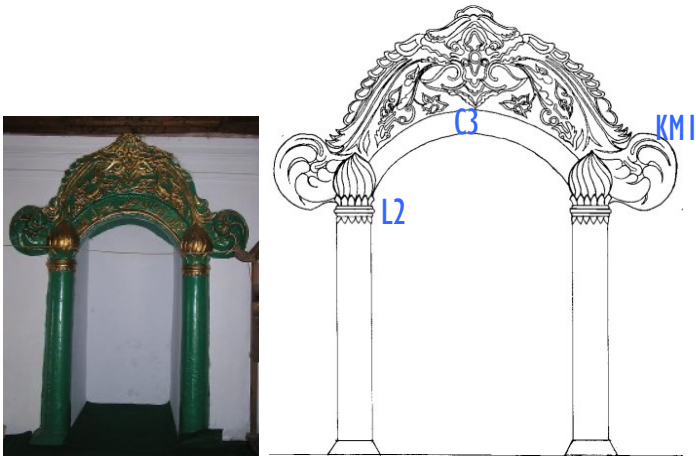

Mihrab (3000 x 2560 cm)

### 8. Al Alam Cilincing, Jakarta, West Java (c.1520)



Location: Cilincing village, sub-district of Cilincing, Jakarta. Founder: Fataillah.

The mosque used as a military base from Cirebon and Demak to chase away the Portuguese in Sunda Kelapa in 1527. It is bordered by a river in the east. The original building has the main room (10 x 10 m), a two-piled roof and a mustaka on the top. The mosque is simple, implying its construction during the war. It lacks of minaret and serambi.

CODES: ARABESQUE, CALLIGRAPHY(1I); ARABESQUE, CALLIGRAPHY(2I); TUMPAL(3P); LOTUS BUD(4P)

A1. M (wood), D (decorated with calligraphy), Ch (circular, continuous, curved, repetitive, rhythmic)
C2. M (wood), D (decorated with arabesque), Ch (curved, mathematical, mystical)

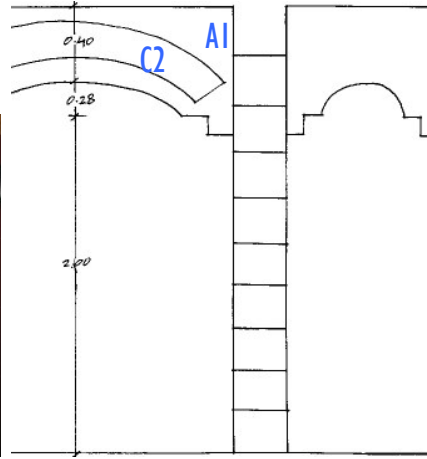

Mihrab (2730 x 2720 cm)

### 9. Hidayatullah, Jakarta, West Java (1750)



Location: Karet Depan, Jakarta. Founder: Muslims from Karet Depan region. Architect: IAI.

The mosque has a characteristic style of the biggest city in the 20<sup>th</sup> century's Java. It has two towers with a Chinese roof style. The terracotta tiles (30 x 30 cm) show the same material in old Angke or Marunda mosque. The mosque has a combination of Islamic and local ornaments. Colour, texture, and materials try to combine the aspect of universal sources and locality. Islamic architecture is shown in a dome with curved, eight-starred geometry, calligraphy, and arabesque, while the local source demonstrates in detailed designs, taken from batik. Behind a carved minbar, Arabic-Melayu calligraphy writes on the wall. In the past, the mosque situates in the place, where Chinese Muslims worked with batik. The mihrab displays orthodox Islamic ornaments, despite different styles from those in the Arab world. Green colour represents Islam, while violet is done for spiritual, calling concentration on prayer.

CODES: ARABESQUE, CALLIGRAPHY(11); LOTUS BUD, SCROLL(2P); ARABESQUE, CALLIGRAPHY(2I); ARABESQUE, GEOMETRY, CALLIGRAPHY(3I)

A1. M (plaster), D (decorated with calligraphy), Ch (circular, continuous, curved, infinite, mathematical, regular, repetitive, rhythmic)
C2. M (plaster), D (decorated with arabesque), Ch (curved, rectilinear, mathematical, mystical)

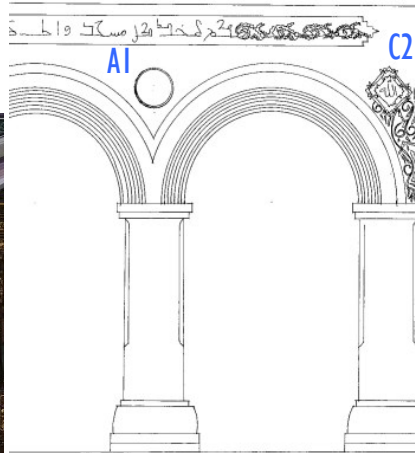

Mihrab (3700 x 4760 cm)

## 10. Kasunyatan, Banten, West Java (1522-70)



Location: Kasunyatan village, sub-district of Kaseman, Banten. Founder: Sultan Maulana Yusuf (Sultan Banten).

The mosque is situated beside the Banten River and could build between 1522 and 1570. The prayer hall is rectangular with a three-piled roof and sokoguru, showing a traditional structure. The gate pierced by a circular opening and capped with the modelled abstraction of kala-makara. The walls between the pilasters perforated with a series of four grills of various designs. The floor was covered with white ceramics during the renovation, instead of red terracotta. The mihrab resembles that of Agung Banten. Vaulted in brick and entered through an arched opening, it is flanked by double pilasters and surmounted by the abstract, floriated kala-makara, common to other west Javanese examples.

CODES: KALA-MAKARA(1P); CALLIGRAPHY(1I); KALA-MAKARA, LOTUS BUD(2P); CALLIGRAPHY(2I); KALA-MAKARA, LOTUS BUD(4P); CALLIGRAPHY(4I)

KM1. M (plaster), D (decorated with calligraphy)	
I: Shape	Geometric (circular, oval, rectangular: dynamic, assorted, abstract, smooth/complicated, small/big)
E: Colour (coloured), P: Unity-variety (unified)	
C2. M (wood), D (not decorated), Ch (curved, geometric, mystical)	

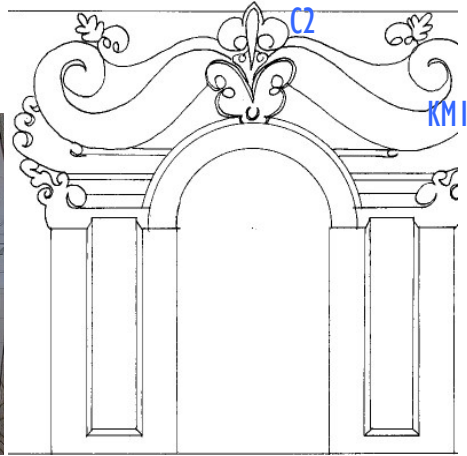

Mihrab (2550 x 2360 cm, renovated)

## 11. Al-Alam Marunda Mosque, Java West (1527)



Location: Marunda village, sub-district of Cilincing, Jakarta. Founder: Fatahillah.

No data are clear about the mosque construction, but the local tradition connected it with the Fatahillah army after a victory over the Portuguese in Sunda Kelapa. The mosque used for prayer and defence shelter. As it borders with Marunda Beach and the living complex at that time, a boat or other means are needed to arrive there. The building has 8 x 8 m with a two piled roof and sokoguru. The columns inspired by the Greek Doric style but are thicker and shorter.

CODES: SCROLL(1P), CALLIGRAPHY(1I)

S1. M (wood), D (decorated with calligraphy)	
I: Rhythm	Regular (diagonal: repetitive, harmonious, single, weak, continuous)
E: Texture (smooth), P: Proportion (non-progressive)	
C2. M (wood), D (decorated with scroll), Ch (curved, geometric, mathematical, mystical)	

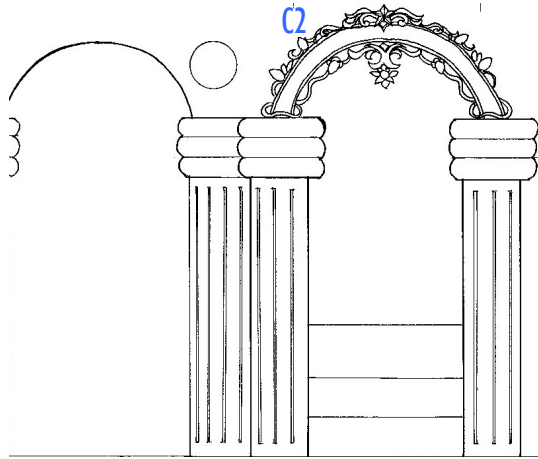

Mihrab (2100 x 2960 cm)

## 12. Sunan Kalijaga, Demak, Central Java (1533)



Location: Kadilangu village, district of Demak, Demak. Founder: Sunan Kalijaga and Prince Wijil.

The mosque was built for the regular prayer of the community. A photograph taken in 1968 shows that the building was sheltered by a three-tiered roof clad with wooden shingles, terminating with a three-necked mustaka at its summit. The building stands in an open space independent of the walled graveyard of Sunan Kalijaga. The mihrab has a version of kala-makara, resembling the Chinese flame. The upper part of the mihrab painted in white; the lower part is with pink coloured tiles.

CODES: KALA-MAKARA(1P); KALA-MAKARA, LOTUS BUD, SCROLL(2P); CALLIGRAPHY(2I); TUMPAL(3P); CALLIGRAPHY(3I); KALA-MAKARA, LOTUS BUD, SCROLL(4P)

KM1. M (plaster), D (not decorated)	
I: Shape	Geometric (circular, oval; dynamic, assorted, abstract, smooth, small/big)
E: Colour (coloured), P: Unity-variety (unified)	

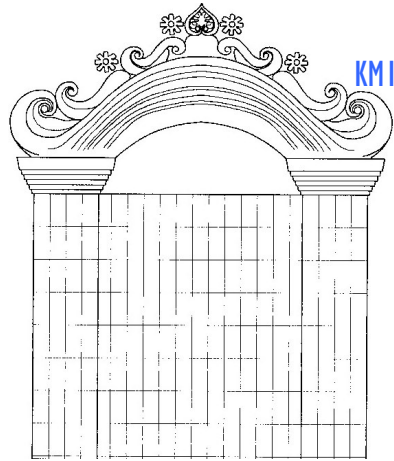

Mihrab (2790 x 2060 cm)

### 13. Menara Kudus (Al-Aqsa Kudus), Kudus, Central Java (1537)



Location: Kauman village, sub-district of Kudus city, district of Kudus.  
 Founder: Sunan Kudus.

The mosque bears a significance of disseminating Islam. “Menara” in Arabic means as a fireplace or place of illumination, and a place to give signals. It combines of Javanese, Hindu and Islamic architecture and ornament, such as the building shape and carved ornaments of Majapahit. Simple Islamic spirals appeared in the tower. The prayer hall has a decorative teak wood paduraksa and an upside down tumpal on creeping plates. The mosque structure is almost not original. The mihrab with a vaulted ceiling line with glazed terracotta tiles forming a high dado. Under the arched opening flanked by two pilasters, a drape of red-gold tiled tumpal motif hangs. Above it is a gilded disc of radiating lines, resembling the Majapahit surya.

CODES: TUMPAL, ARABESQUE, GEOMETRY, CALLIGRAPHY(1I); TUMPAL, KALA-MAKARA, LOTUS BUD, SCROLL(2P); ARABESQUE, GEOMETRY, CALLIGRAPHY(2I); GEOMETRY, CALLIGRAPHY(3I); KALA-MAKARA, LOTUS BUD, SCROLL(4P); CALLIGRAPHY(4I)

T1. M (tile), D (not decorated)	
I: Line	Straight/curved (vertical, horizontal, diagonal/circular, unbroken, geometrical, inner, short/long, simple)
E: Space (narrow), P: Emphasis (dominant)	
A2. M (tile), D (decorated with geometry), Ch (anti-natural, circular, continuous, curved, regular, repetitive, rhythmic, symmetric)	



G3. M (wood), D (not decorated), Ch (abstract, circular, continuous, geometric, mathematical, regular, repetitive, symmetric)

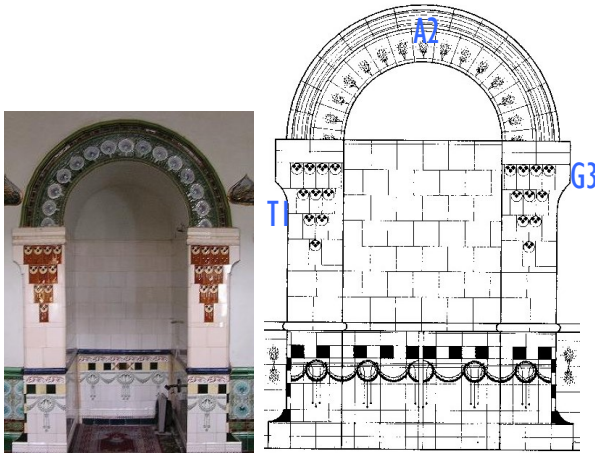

Mihrab (1650 x 1785 cm, renovated)

#### 14. Agung Jepara, Java Central (1549)



Location: West side of fields the district city of Jepara. Founder: Sultan Hadlirin.

The present mosque is the last renovation of 1999. It has a two-piled tajug roof and concrete columns to provide more space for the pawstren (woman prayer room) to the left. The mosque, using the famous teakwood and carpentry skill in this area, is full of local and

Islamic influences. The best example can see in the work of wooden scroll and calligraphy.

CODES: SCROLL(1P); GEOMETRY, CALLIGRAPHY(1I); TUMPAL, LOTUS BUD, SCROLL(2P); GEOMETRY, CALLIGRAPHY(2I); SCROLL(3P); LOTUS BUD(4P); GEOMETRY, CALLIGRAPHY(4I)

S1. M (wood), D (decorated with calligraphy)	
I: Rhythm	Regular (vertical, horizontal, diagonal: repetitive, harmonious, single, strong, continuous)
E: Texture (smooth), P: Proportion (progressive)	
G2. M (wood), D (not decorated), Ch (abstract, circular, continuous, geometric, mathematical, mystical, regular, repetitive)	
C3. M (wood), D (decorated with scroll), Ch (curved, geometric, mathematical, mystical)	

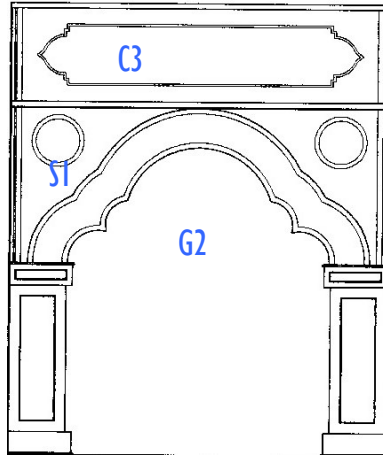
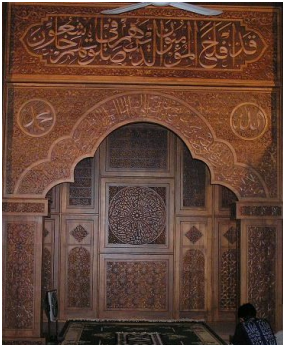

Mihrab (7920 x 3620 cm, renovated)

### 15. Astana Mantingan, Jepara, Central Java (1559)



Location: Mantingan village, sub-district of Jepara, district of Jepara.

Founder: Queen Kalinyamat and Prince Hadiri.

The mosque is a grave mosque, built by Queen Kalinyamat. Mantingan means: (i) the word “pamantingan” as the place of business, and (ii) the name of tree manting/hallo for cooking. It has a traditional Javanese style with famous panels on its front wall, such as a medallion shape with interlace and floral motifs, six angled shape with plant motifs, rectangular shape with kala and cross motifs. Medallions show a pre-Islamic style, despite Islamic geometric interlace on them. The mihrab consists of a simple vaulted space entered through a low relief arch. Three carved stone medallions with latticed geometric motifs were set in the wall, one at the rear of the mihrab and two superimposed above the arch. The medallion inside has four winged tendrils enclosing to form a square.

CODES: TUMPAL, SCROLL(1P); GEOMETRY(1I); TUMPAL, SCROLL(2P); GEOMETRY(2I); TUMPAL, LOTUS BUD(3P); TUMPAL, KALA-MAKARA, LOTUS BUD(4P); CALLIGRAPHY(4I)

T1. M (stone), D (decorated with scroll)	
I: Line	Curved (spiral, undulating; broken/unbroken, natural, inner/outline, short, complicated)
E: Space (narrow), P: Emphasis (subordinate)	
S2. M (stone), D (not decorated)	
I: Rhythm	Regular (horizontal, diagonal: repetitive, harmonious, single, weak, continuous)
E: Texture (smooth), P: Proportion (progressive)	

G3. M (stone), D (decorated with scroll), Ch (circular, geometric, linear, mathematical, mystical, rhythmic, symmetric)

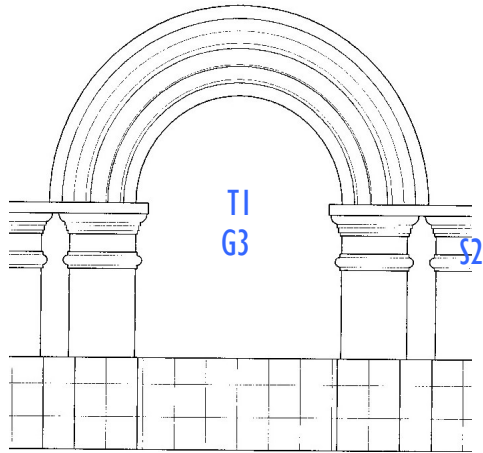

Mihrab (2705 x 3350 cm)

## 16. Sendang Duwur, Paciran, East Java (1561)



Location: Sendang Duwur village, sub-district of Paciran, Lamongan.

Founder: Raden Nur Rahmat, Sunan Sendang Duwur.

The mosque and cemetery incorporate some of the most important architectural details on the cultural change of Java. In terms of a noted decorative style, the mosque is reminiscent of Mantingan mosque (1959). Sited on top of a hill, it has distinct pre-Islamic motifs. One of them is a garuda winged gate. The mihrab is a shallow niche raised on one step in the west wall, and pilasters with half columns support a segmental low relief arch. A glazed circular opening at the eye level penetrates the rear wall of the mihrab, providing illumination as well as ventilation.

CODES: KALA-MAKARA(1P); KALA-MAKARA, LOTUS BUD(2P); TUMPAL, LOTUS BUD, SCROLL(4P); CALLIGRAPHY(4I)

KMI. M (tile), D (not decorated)	
I: Shape	Geometric (oval, triangular, square, rectangular: static, assorted, abstract, smooth, small/big)
E: Colour (coloured), P: Unity-variety (separate)	

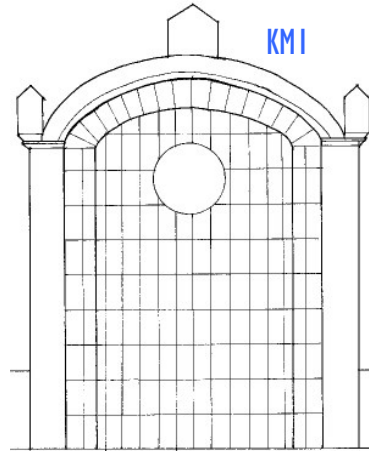

Mihrab (2120 x 1820 cm, renovated)

### 17. Al Makmur Jipang, Jepara, Central Java (1561-77)



Location: Jipang village, sub-district of Mejobo, district of Kudus.

Founder: Arya Penangsang.

The name “Al Makmur” was derived from a famous person in the Jipang kingdom, Arya Jipang or Arya Penangsang. The mosque has a square layout (10.4 m<sup>2</sup>) with a two-tiered roof. It has an old gate which has a rumour of making people mad. The minbar was made in China in 1868. The founder was Sultan Prawoto’s son and grandchild of Demsk Sultan Trenggana.

**CODES: TUMPAL, KALA-MAKARA, LOTUS BUD(1P); CALLIGRAPHY(1I); TUMPAL, KALA-MAKARA, LOTUS BUD(2P); CALLIGRAPHY(2I); LOTUS FLOWER(3P); CALLIGRAPHY(3I); CALLIGRAPHY(4I)**

T1. M (wood), D (decorated with kala-makara, lotus bud)	
I: Line	Straight (vertical, horizontal, diagonal: unbroken, geometrical, outline, long, simple)
E: Space (wide), P: Emphasis (subordinate)	
KM2. M (wood), D (decorated with tumpal, lotus bud)	
I: Shape	Geometric (circular, oval, triangular: dynamic, assorted, abstract, smooth, big)
E: Colour (coloured), P: Unity-variety (unified)	
L3. M (wood), D (decorated with tumpal, kala-makara)	
I: Form	Primary (spherical: slender, closed, stylised, static, 2-3 dimensional)
E: Value (light), P: Size (small)	
CA. M (wood), D (decorated with tumpal, kala-makara, lotus bud), Ch (curved, geometric, mathematical, mystical)	

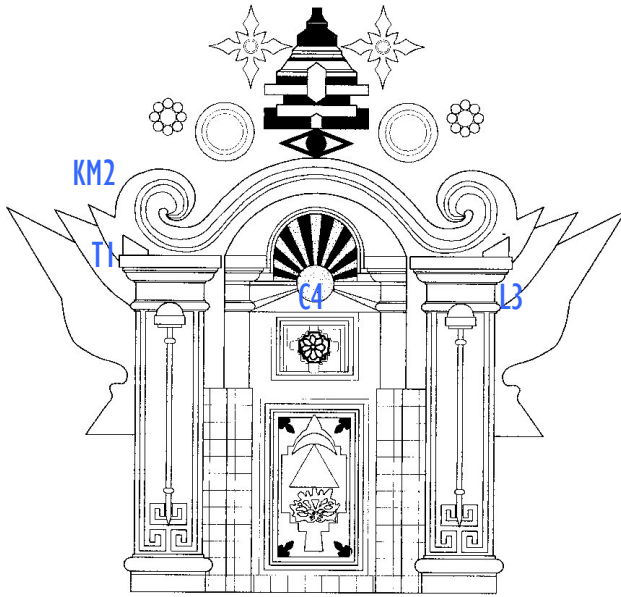

Mihrab (2550 x 2150 cm)

**18. Agung Mataram, Yogyakarta, Central Java (1568-1601)**



Location: Jagalan village, sub-district of Banguntapa, Kotagede, Yogyakarta. Founder: Panembahan Senopati.

As Kotagede was the capital of Islamic Mataram kingdom, the whole religious complex suggests an archaic site with royal tombs. The compound walls, paduraksa, and kala have pre-Islamic characteristics. And freestanding walls behind the mosque which deflects the entry of

malign spiritual forces are reminiscent of those found in Balinese temples. The mosque's main axis does not represent the direction of prayer, and the mihrab is not on the axis between the central east door and the centre point of sokoguru. The vaulted mihrab contains many small rooms, forming a pavilion. And an extended shape of floriated wings projects on each side at the top.

CODES: KALA-MAKARA, LOTUS FLOWER WITH SCROLL(1P); CALLIGRAPHY(1I); KALA-MAKARA, LOTUS FLOWER WITH SCROLL(2P); CALLIGRAPHY(2I); TUMPAL, KALA, LOTUS SCROLL(4P)

KMI. M (plaster), D (decorated with scroll)	
I: Shape	Geometric (oval, triangular, square, rectangular: static, assorted, abstract, smooth, small/big)
E: Colour (coloured), P: Unity-variety (unified)	
S2. M (plaster), D (decorated with kala-makara)	
I: Rhythm	Irregular (repetitive, disharmonious, multiple, weak, continuous)
E: Texture (rough), P: Proportion (non-progressive)	

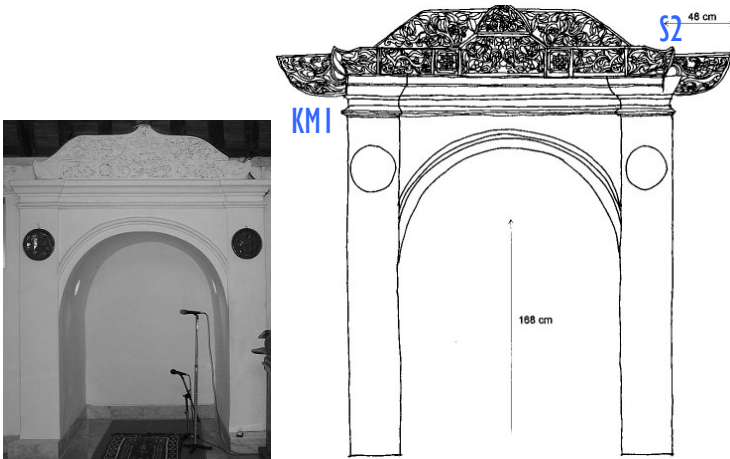

Mihrab (3120 x 3140 cm)

**19. Kauman Semarang, Semarang, Java Cental (1575)**

Location: Jl. Kauman, Semarang. Founder: Sunan Pandan Arang.



The mosque is a combination of the old mosque and additional buildings built by a Dutch architect, Gambier. It has a rectangular type with five doors. Not like a traditional Javanese style, a closed roof structure is a Dutch colonial style. The mihrab displays a beautiful decoration of Islamic calligraphy.

CODES: GEOMETRY, CALLIGRAPHY(1I); LOTUS BUD, SCROLL(2P); GEOMETRY, CALLIGRAPHY(2I); SCROLL(3P); LOTUS BUD(4P); GEOMETRY, CALLIGRAPHY(4I)

Cl. M (wood), D (not decorated), Ch (curved, rectilinear, mathematical, mystical)

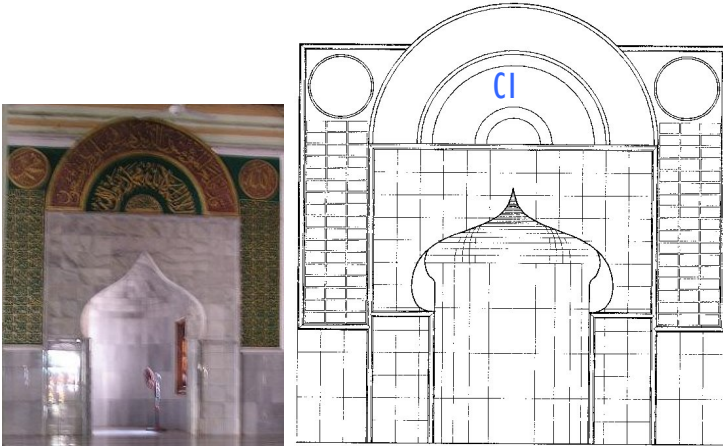

Mihrab (2850 x 3240 cm, renovated)

**20. Kanari, Banten, West Java (1596-1651)**



Location: Kanari village, sub-district of Kasemen, province of Banten.

Founder: Sultan Banten IV.

The mosque is small and simple. In the north, there is a grave complex, including Sultan Banten III, Sultan Muh, and Sultan Banten IV. The building has two parts: a rectangular prayer hall with a two-piled roof, and serambi with a limasan roof. The prayer hall has sokoguru and a unique minbar. There is a big pool for spiritual washing. As one of the three oldest mosques in Banten (Kasunyatan and Agung Banten), the founder is Sultan Banten IV whose title was given by Mecca. The construction is not precise, probably between 1596 and 1651 during Sultan Kenari's rule.

CODES: KALA-MAKARA(1P); GEOMETRY(1I); KALA-MAKARA, LOTUS BUD, SCROLL(2P); ARABESQUE, GEOMETRY(2I); KALA-MAKARA, LOTUS BUD(4P); GEOMETRY, CALLIGRAPHY(4I)

KM1. M (plaster), D (decorated with geometry)	
I: Shape	Geometric (circular, oval, triangular, square; dynamic, assorted, abstract, smooth/complicated, big)
E: Colour (coloured), P: Unity-variety (unified)	

G2. M (plaster), D (decorated with kala-makara), Ch (abstract, continuous, geometric, linear, regular, repetitive, rhythmic, symmetric)

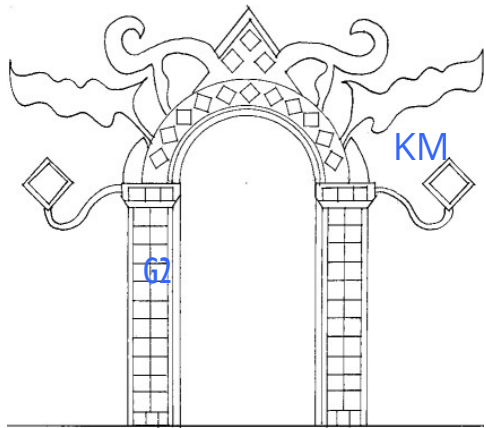

Mihrab (2500 x 1440 cm, renovated)

## 21. Jami Kanoman, Cirebon, West Java (1679)



Location: Kanoman palace, Cirebon. Founder: Sultan Badruddin (Sultan Kanoman I).

The mosque is a legal mosque of Kanoman Palace, but the function as a Friday mosque ended in 1980. The prayer hall is rectangular with a two-piled roof and a mustaka on it. A narrow serambi has classical sokoguru, and an open floor style shows a colonial influence. A combination of gold and green colours of the mihrab indicates the glory of Islamic kingdom and religion respectively.

CODES: KALA-MAKARA, LOTUS BUD(1P); GEOMETRY, CALLIGRAPHY(1I); KALA-MAKARA, LOTUS BUD(2P); GEOMETRY, CALLIGRAPHY(2I); LOTUS BUD(3P); GEOMETRY(3I)

KM1. M (wood), D (decorated with lotus bud, calligraphy)	
I: Shape	Natural (dynamic, assorted, illustrating, smooth/complicated, small/big)
E: Colour (coloured), P: Unity-variety (unified)	
L2. M (wood), D (decorated with kala-makara, calligraphy)	
I: Form	Primary (spherical: voluminous, open, stylised, dynamic, 2-3 dimensional)
E: Value (dark), P: Size (big)	
G3. M (tile), D (not decorated), Ch (continuous, curved, geometric, regular, repetitive, rhythmic)	
C4. M (wood), D (decorated with kala-makara, lotus bud), Ch (curved, linear, mathematical, mystical)	



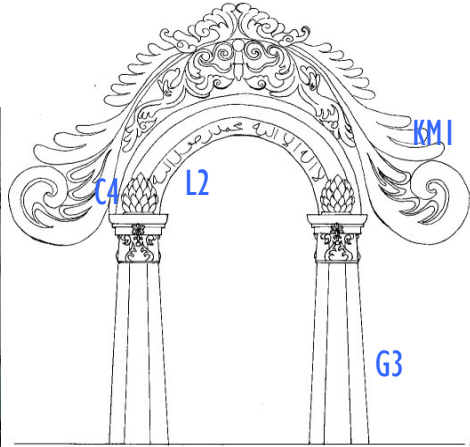

Mihrab (3400 x 3430 cm)

## 22. Al-Mansyur Sawah Lio, Jakarta, Java West (1717)



Location: Jembatan Lima village, sub-district of Tambora, west Jakarta.  
 Founder: Abdul Malik (Tumenggung Mataram).

The mosque is one of the oldest colonial mosques in Jakarta. The most exciting part in the prayer hall is four thick Greek Doric columns which connect blocks for making a bridge. In its development, the mosque was used as a post to fight against the Dutch until 1949, putting the red, white flag. It has a three-piled roof with a cylindrical tower for calling prayer. The mihrab is completely renovated in the use of modern material of neon sign but keeps still Hindu-Buddhist motifs of kala-makara and lotus bud in an abstract form. The awareness of cultural heritage is significant.

CODES: KALA-MAKARA, LOTUS BUD(1P); CALLIGRAPHY(1I); CALLIGRAPHY(2I); LOTUS BUD, SCROLL(3P); CALLIGRAPHY(3I); KALA-MAKARA(4P); CALLIGRAPHY(4I)

KM1. M (plastic), D (decorated with lotus bud, calligraphy)	
I: Shape	Geometric (oval, rectangular: static, assorted, abstract, smooth, big)
E: Colour (coloured), P: Unity-variety (separate)	
L2. M (plastic), D (decorated with kala-makara, calligraphy)	
I: Form	Primary (spherical: slender, open, stylised, static, 2-3 dimensional)
E: Value (light), P: Size (small)	
C3. M (plastic), D (decorated), Ch (curved, geometric, linear, mathematical, mystical)	

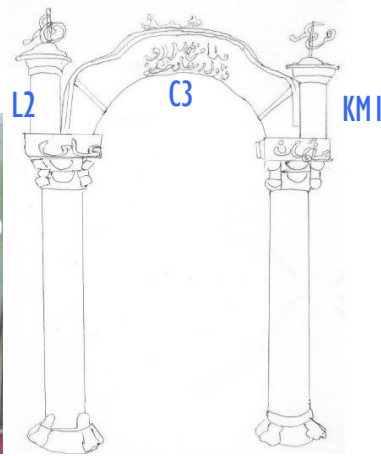

Mihrab (3000 x 3500 cm, renovated)

### 23. Agung Surakarta, Solo, Java Central (1757)



Location: Panemahan district of village, sub-district of Palace, Solo.

Founder: Sri Susuhanan PK III.

The mosque was built for a royal family after splitting the Mataram kingdom into Yogya and Solo. The minaret resembles that of Kutub Minor in New Delhi, India. The serambi with 40 wooden rectangular columns is surrounded by water for the spiritual washing. A rectangular prayer hall has a three-piled roof and sokoguru. Of ornamentation, gold gilded natural lotus flowers decorate the prayer hall for meditation. Geometric ornaments are arranged on the floor, attracting the eyes of the prayer. The mosque is full of surprise by its elegance.

CODES: KALA-MAKARA, LOTUS BUD(1P); GEOMETRY, CALLIGRAPHY(1I); SCROLL(2P); GEOMETRY, CALLIGRAPHY(2I); TUMPAL, SCROLL(3P); GEOMETRY, CALLIGRAPHY(3I); LOTUS BUD(4P); GEOMETRY(4I)

KM1. M (tile), D (decorated with lotus bud, geometry, calligraphy)	
I: Shape	Geometric (circular, oval, rectangular: static, single, abstract, smooth, big)
E: Colour (coloured), P: Unity-variety (unified)	
L2. M (wood), D (decorated with kala-makara, geometry, calligraphy)	
I: Form	Primary (spherical: slender, open, stylised, static, 3-dimensional)
E: Value (light), P: Size (big)	
C3. M (tile), D (not decorated), Ch (abstract, curved, continuous, geometric, linear, regular, repetitive, rhythmic, symmetric)	
C4. M (wood), D (not decorated), Ch (curved, mathematical, mystical)	

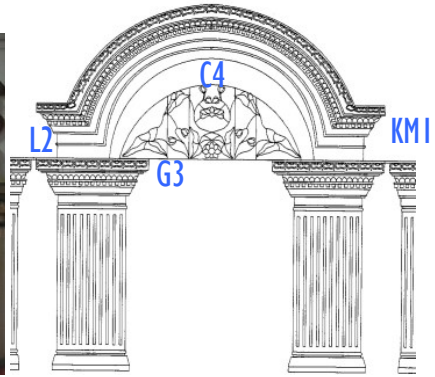

Mihrab (4070 x 2330 cm)

**24. Al Anwar Angke, Jakarta, West Java (1761)**



Location: Angke village, sub-district of Tambora, Jakarta. Founder: Prince Ahmad Jayakarta.

It says that Chinese Muslims built the mosque which was a meeting place for fighters from Banten and Cirebon. It was also a hidden place for the Chinese when VOC took control over Java. The mosque is a mono building with a two-piled roof and has a combination of Javanese roof, sokoguru, European door and window, and Chinese construction. The 45 m high minaret signalises Indonesian independence in 1945.

CODES: CALLIGRAPHY(2I); SCROLL(3P); TUMPAL, KALA-MAKARA, LOTUS BUD(4P)

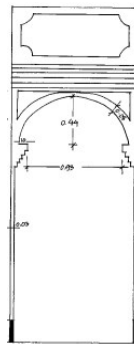
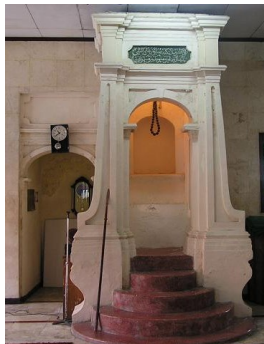

Mihrab (3130 x 1130 cm)

**25. Agung Yogya, Yogyakarta, Central Java (1773)**



Location: Ngupasan village, sub-district of Gondomanan, Yogyakarta. Founder: Sri Sultan Hamengkubuwono I. Architect: K. Wiryakusumo.

The royal mosque has a three-piled tajug roof, teak wood sokoguru (4), sokorawa (12), sokoemper (20), and maksura for a king to pray. Besides, the gamelan music played during festivals in honour of the Prophet. The 24 columns on the serambi carved in Yogyakarta traditional style. Even their colours were intentionally chosen to suit its function. Pillars and beams adjoined by a European method. Both outer and inner forts and sturdy walls of the mosque provided shelter for refuge during the colonial period. The arched mihrab is a half circle. On its both side, a combination of floral ornament and Arabic calligraphy appears. Motifs of plants, mountain, and drop of water are everywhere, such as on mihrab, minbar, maksura and columns in the prayer hall and serambi. The juxtaposition of floral and geometric motifs in the serambi is the most beautiful ornamentation among Javanese mosques.

CODES: LOTUS BUD WITH SCROLL(1P); CALLIGRAPHY(1I); TUMPAL, LOTUS BUD WITH SCROLL(2P); CALLIGRAPHY(2I); TUMPAL(3P); TUMPAL, LOTUS BUD(4P)

S1. M (wood), D (decorated with calligraphy)	
I: Rhythm	Regular (horizontal: repetitive, harmonious, single, strong, continuous)
E: Texture (smooth), P: Proportion (non-progressive)	
C2. M (wood), D (decorated with scroll), Ch (curved, linear, mathematical, mystical)	

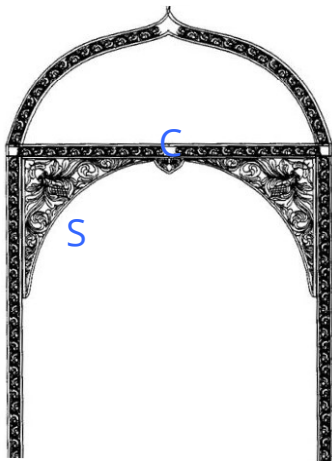

Mihrab (3000 x 2100 cm)

**26. Menara Kampung Melayu, Semarang, Java Central (c.1820)**



Location: Village Kampung Melayu, sub-district of North Semarang.  
 Founder: local people.

Melayu village has a characteristic feature, combined of Arabic, Chinese, and Javanese cultures. Javanese influence can be seen from a rectangular type with a three-piled tajug roof. The Melayu Banjar style is in the structure of the wood platform, used in Banjar homes. The location of the mosque near the river and residential area with small roads can suggest its construction done by Arabs.

CODES: GEOMETRY(1I); GEOMETRY(2I); GEOMETRY(3I); LOTUS BUD(4P); ARABESQUE, GEOMETRY, CALLIGRAPHY(4I)

G1. M (tile), D (not decorated), Ch (abstract, continuous, geometric, rectilinear, regular, repetitive, symmetric)



Mihrab (3240 x 2850 cm)

**27. Jami Robayan, Jepara, Java Central (1850)**



Location: Robayan village street, district of Jepara. Founder: unknown.  
 The mosque with a dome reminds of Indian Mogul style. The prayer hall is squared with 10.8 m long and has a tajug roof and sokoguru. The design of the door is a colonial style, due to its construction during the Dutch colonisation of Java. The domed serambi on the corner of the east was built in the 20<sup>th</sup> century. Except for a simple

geometric motif on the mihrab, the prayer hall is very simple, compared with the use of pre-Islamic and Islamic motifs outside.

CODES: **GEOMETRY(1I)**; **SCROLL(2P)**; **CALLIGRAPHY(2I)**; **GEOMETRY, CALLIGRAPHY(3I)**; **KALA-MAKARA, LOTUS BUD(4P)**; **GEOMETRY, CALLIGRAPHY(4I)**

G1. M (tile), D (not decorated), Ch (abstract, circular, continuous, geometric, regular, repetitive, rhythmic)

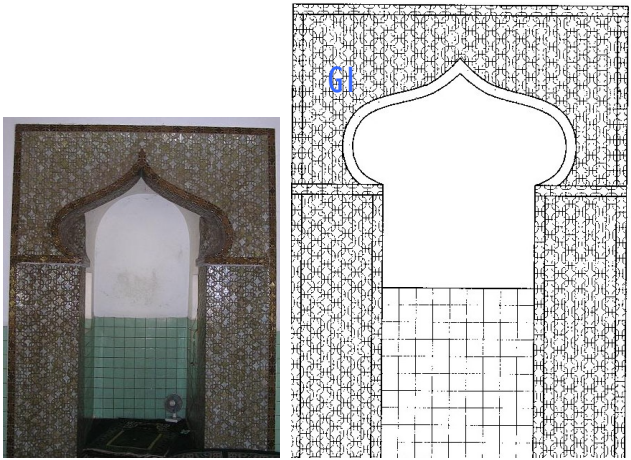

Mihrab (2650 x 1980 cm)

**28. Agung Malang, Malang, East Java (1853-90)**



Location: District Malang, Malang. Founder: Malang Regent. Architect: the Dutch.

The mosque is rectangular with a three-piled-roof. The prayer hall is combined of two buildings from different times with sokoguru and sokorawa. The mihrab in the east wall has an East Javanese character. Among its three rooms, the middle is the mihrab, while others are for Koran reading and speeches. On the right side of the prayer hall, there is a classical serambi. When an extra building was built in 1890, the mihrab moved in here. After independence, the mosque enlarged, but the cemetery removed. An arched mihrab with golden scroll and lotus bud underlines the significance of mihrab ornamentation, compared simple geometric tiles around it.

CODES: **LOTUS BUD, SCROLL(1P)**; **GEOMETRY(1I)**; **TUMPAL, LOTUS BUD, SCROLL(2P)**; **GEOMETRY, CALLIGRAPHY(2I)**

L1. M (wood), D (decorated with scroll)



I: Form	Primary (conic: slender, open, stylised, static, 3-dimensional)
E: Value (light), P: Size (small)	
S2. M (wood), D (decorated with lotus bud)	
I: Rhythm	Irregular (non-repetitive, disharmonious, multiple, weak, discontinuous)
E: Texture (rough), P: Proportion (non-progressive)	
G3. M (wood, tile), D (not decorated), Ch (abstract, continuous, geometric, linear, regular, repetitive)	

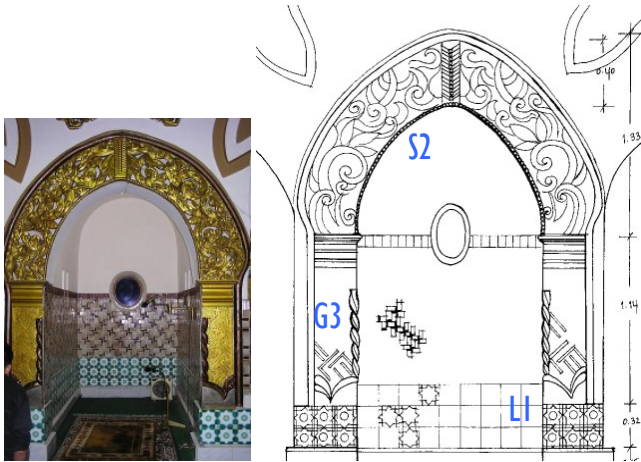

Mihrab (2940 x 1840 cm)

## 29. Al Wustho Mangkunegara, Solo, Central Java (1878-1918)



Location: Ketelan village, sub-district of Banjarsari, Surakarta.  
 Founder: Prince Adipati. Mangkunegara XII. Architect: Thomas Karsten.

The mosque complex has about 4,200 m<sup>2</sup>, surrounded by brick walls. It has much influence from the colonial style, designed by Karsten, a Dutch architect. Moreover, the mosque itself has a unique element of a baldachin which is not common in traditional mosques. The influence of the colonial style can also be seen inside, despite a traditional Javanese style of the prayer hall with a rectangular room, sokoguru, and a three-piled tajug roof. The pillars are small in size, decorated with carved ornament and calligraphy. Between the roof, there are glasses to get sunlight, reminding of Persian mosques. The gate of the mosque has a distinct shape, decorated with Arabic calligraphy.

CODES: KALA-MAKARA, LOTUS FLOWER SCROLL(1P); TUMPAL, KALA-MAKARA, LOTUS FLOWER, SCROLL(2P); CALLIGRAPHY(2I); GEOMETRY, CALLIGRAPHY(3I); CALLIGRAPHY(4I)

KMI. M (wood), D (decorated with scroll)	
I: Shape	Geometric (triangular, rectangular: static, single, abstract, smooth/complicated, big)
E: Colour (original), P: Unity-variety (separate)	
S2. M (wood), D (decorated with kala-makara)	
I: Rhythm	Regular (vertical, horizontal, diagonal: non-repetitive, harmonious, single, strong, continuous)
E: Texture (smooth), P: Proportion (non-progressive)	



Mihrab (3150 x 2600 cm)

### 30. Kampung Nembol, Banten, West Java (1880)



Location: Nembol village, sub-district of Labuan, district of Pandeglang. Founder: Syekh Sholeh Zubaid.

The mosque has 7 x 7 m<sup>2</sup> with a three-piled roof and sokoguru. Two mihrabs find in the prayer hall, but one is for accommodating minbar. The foundation date of the mosque is still unknown but probably built before Cikadueun mosque and Caringin mosque around 1880. Syekh Soleh Zubaid, a Palestinian Muslim missionary, is the founder. It says that the mosque was erected during a night by his supernatural power. Despite its location on the isolated hill, surprisingly, the mosque has pre-Islamic and Islamic motifs, done by local people.

CODES: LOTUS BUD, SCROLL(1P); ARABESQUE, CALLIGRAPHY(1I); KALA-MAKARA, LOTUS BUD, SCROLL(2P); ARABESQUE, CALLIGRAPHY(2I); LOTUS BUD, SCROLL(3P); CALLIGRAPHY(3I); LOTUS BUD(4P)

LI. M (wood), D (decorated with scroll, arabesque, calligraphy)
---



I: Form	Non-primary (slender, open, realistic, dynamic, 2-3 dimensional)
E: Value (dark), P: Size (small)	
S2. M (wood), D (decorated with lotus bud, arabesque, calligraphy)	
I: Rhythm	Regular (vertical, horizontal: repetitive, harmonious, single, strong, continuous)
E: Texture (rough), P: Proportion (non-progressive)	
A3. M (plaster), D (decorated with calligraphy), Ch (circular, continuous, curved, infinite, repetitive, rhythmic)	
C4. M (plaster; wood), D (decorated with scroll), Ch (curved, geometric, linear, mathematical, mystical)	

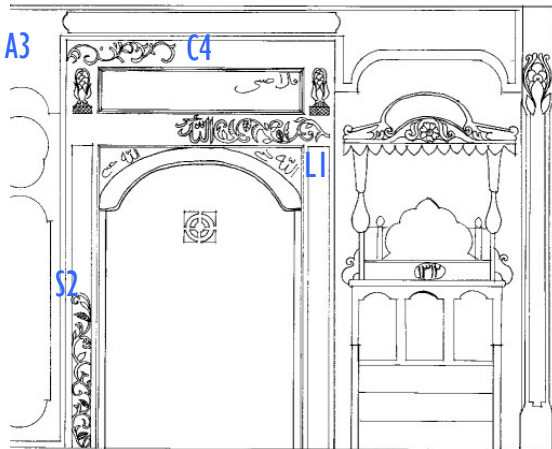

Mihrab (3820 x 4000 cm)

### 31. Caringin Labuan, Banten, West Java (1883-93)



Location: Caringin village, sub-district of Labuan, district of Pandeglang. Founder: Syekh Asnawi.

The mosque is one of the oldest mosques built during the Dutch colonisation by Syekh Asnawi. As he was a fighter against the Dutch, the mosque was used for the defence. Its territory is 2,500 m<sup>2</sup>, surrounded by a high wall, a two piled-roof, and serambi. The prayer hall is rectangular with sokoguru, but the serambi has classical columns. The mosque bears a combination of Javanese traditional and colonial styles. Although the mosque needed ten years to complete, according to a legend, sokoguru, made of Kalimantan teakwood, was placed in one night. During the renovation in 1984, the tile replaced wood on the roof.

CODES: LOTUS BUD(1P); CALLIGRAPHY(1I); KALA-MAKARA, LOTUS BUD, SCROLL(2P); CALLIGRAPHY(2I); SCROLL(3P)

L1. M (tile), D (not decorated)	
I: Form	Non-primary (slender, open, realistic, dynamic, 2-3 dimensional)
E: Value (light), P: Size (small)	
C2. M (ceramic), D (not decorated), Ch (curved, geometric, mathematical, mystical)	

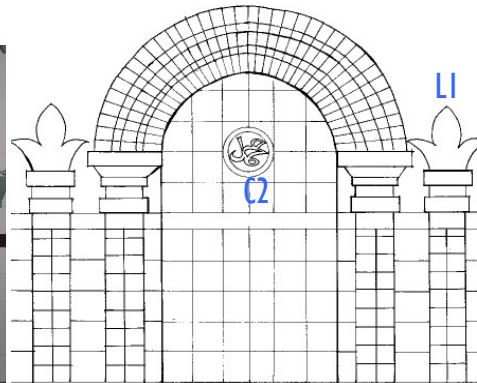
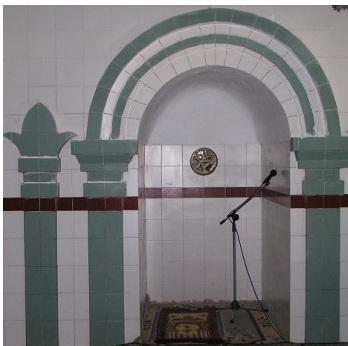

Mihrab (2460 x 2780 cm)

### 32. Carita Labuan, Banten, West Java (1889-95)



Location: Carita village, sub-district of Labuan, district of Pandeglang.  
 Founder: Syekh Al-Khusaini.

This mosque stands on the land where two rivers meet in Labuan-Carita. It is rectangular with a three-piled-roof, and the prayer hall has sokoguru. The building consists of colonial, Javanese, and even Chinese styles. The colonial style is brick columns in the serambi and a thick fence on walls. The founder is a local Muslim leader who studied in Arabia. After his return to Java, he wanted to build a mosque by a Chinese Muslim architect. The mosque was used for a fighting post against the Dutch.

CODES: KALA-MAKARA(1P); TUMPAL, KALA-MAKARA, LOTUS BUD(2P); CALLIGRAPHY(2I); CALLIGRAPHY(3I); TUMPAL(4P); CALLIGRAPHY(4I)

KM1. M (wood), D (not-decorated)	
I: Shape	Geometric (circular, triangular: static, assorted, abstract, smooth/complicated, big)
E: Colour (coloured), P: Unity-variety (separate)	

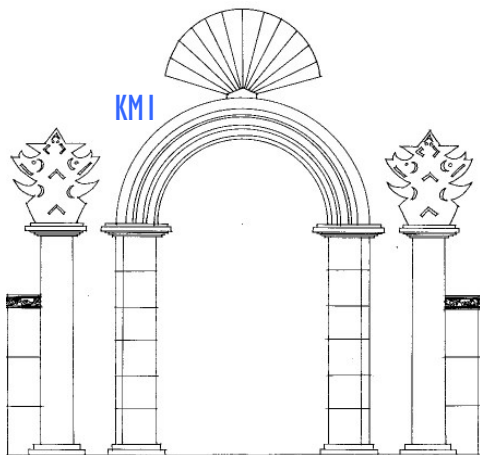

Mihrab (2820 x 2540 cm, renovated)

### 33. Cut Meutia, Jakarta, Java West (1920)



Location: Menteng village, Jakarta, province of the Jakarta region.

Founder: The Dutch Government.

Initially, the mosque was an office building of the Dutch colonial government in Batavia between 1900 and 1920. A Dutch architect Berlage designed it in 1913 and corrected by Van Moonjen. After Independence of Indonesia, the building was taken by the government and changed into a mosque in 1935. The prayer hall has a dome with three levels, connecting to the stairs. High windows with carved mosaic glass permit to sunray and air circulation. Islamic arabesque, geometry, and calligraphy are overall around the mihrab.

CODES: SCROLL(1P); ARABESQUE, GEOMETRY, CALLIGRAPHY(1I); SCROLL(2P); ARABESQUE, GEOMETRY, CALLIGRAPHY(2I); GEOMETRY(3I)

S1. M (wood), D (not decorated)	
I: Rhythm	Regular (vertical, horizontal: repetitive, harmonious, single, strong, continuous)
E: Texture (smooth), P: Proportion (non-progressive)	
A2. M (plaster), D (decorated with geometry, calligraphy), Ch (circular, continuous, curved, infinite, mathematical, regular, repetitive, rhythmic, symmetric)	
G3. M (plaster), D (decorated with arabesque, calligraphy), Ch (abstract, continuous, geometric, linear, mathematical, mystical, repetitive)	
C4. M (wood: plaster), D (decorated with arabesque, geometry), Ch (curved, geometric, linear, mathematical, mystical)	

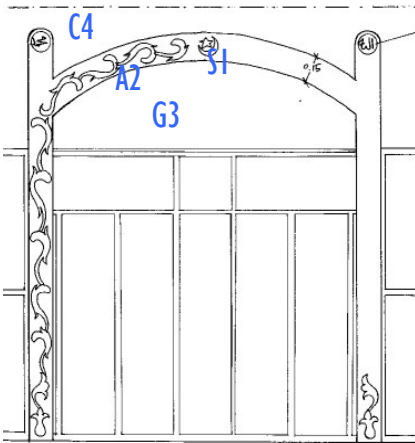

Mihrab (2400 x 3550 cm)

### 34. Raya Cipaganti, Bandung, West Java (1933)



Location: Sub-district of Gibeunying, Bandung. Architect: Wolf Schoemaker.

The mosque is also called “Kauman Cipaganti”, located in a European residential area. It used for Islamic teaching against the Dutch colonialism, but nowadays, is for visiting prayers who come to Bandung, due to its location near the central market of Cihampelas. A famous Dutch architect, Schoemaker designed the mosque. It bears a traditional Javanese style of a two-piled roof with the Dutch technology. During several renovations in demand of a growing population in this area, annexes were added to facilitate the Koran reading and other educational activities. Beautifully carved lotus buds on columns, and abstract kala-makaka on a partition wall remind of a pre-Islamic touch.

CODES: **GEOMETRY, CALLIGRAPHY(11); LOTUS BUD(2P); GEOMETRY, CALLIGRAPHY(2I); KALA-MAKARA(3P); ARABESQUE, GEOMETRY, CALLIGRAPHY(3I)**

G1. M (tile), D (not decorated), Ch (abstract, continuous, geometric, linear, regular, repetitive, symmetric)
C2. M (wood), D (not decorated), Ch (curved, linear, mathematical, mystical)

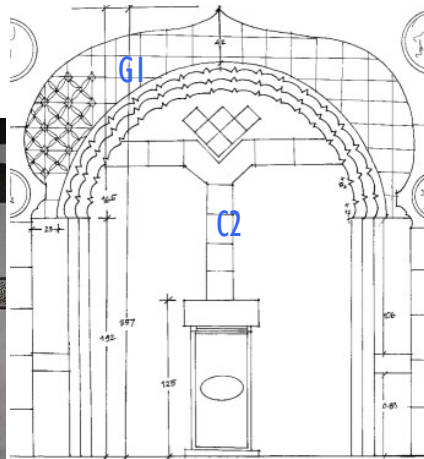

Mihrab (3570 x 3010 cm)

**35. Al Azhar, Jakarta, West Java (1952-8)**



Location: New Kebayoran, Jakarta. Founder: Soedirjo, Tanjung Hok, H. Ghazali Sahlan, H. Suaid.

The name of the mosque took from that of Al Azhar University in Cairo, Egypt, when asy-Syeikh Muhammad Saltut visited in 1960.

The mosque used a cupola roof for the first time in Java, besides Syuhada mosque. It has a prayer hall and multifunction rooms, such as an education centre, a library, an office, etc. Due to a necessity of Islamic centres at the end of the 20<sup>th</sup> century, the mosque suits for its aim: spaces for kindergarten and elementary, junior high, high schools, even university. The mihrab has full of orthodox Islamic ornament.

CODES: ARABESQUE, GEOMETRY, CALLIGRAPHY(1I); ARABESQUE, GEOMETRY, CALLIGRAPHY(2I); LOTUS BUD(3P); LOTUS BUD(4P); CALLIGRAPHY(4I)

A1. M (plaster), D (decorated with geometry), Ch (circular, continuous, curved, geometrical, infinite, mathematical, repetitive, rhythmic)
G2. M (plaster), D (decorated with arabesque), Ch (abstract, circular, geometric, mathematical, repetitive, rhythmic)
C3. M (plaster), D (decorated with arabesque), Ch (curved, geometric, linear, mathematical, mystical)

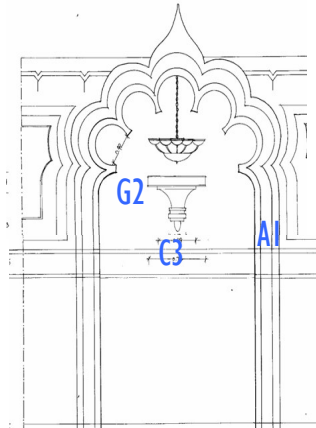

Mihrab (3570 x 3010 cm)

**36. Sunda Kelapa, Jakarta, West Java (1969-71)**



**Location:** Sub-district of Menteng, Jakarta. **Founder:** Alamsyah Ratu Prawiranegara.

The construction of the mosque took two years. This Friday prayer mosque is divided into two floors with a contemporary style, taking an idea from Salam ITB mosque in Bandung. For examples, the mosque has a horizontal concrete roof, neither a dome nor a piled-roof. And the prayer hall does not have columns in the context of functionalism. It is located on the upper part, while office, library, meeting room, and ablution are on the lower. However, abstract lotus buds on the mihrab express Javanese Muslims' concern on the pre-Islamic tradition, along with the acceptance of orthodox Islamic ornament at the same time.

**CODES:** LOTUS BUD(1P); ARABESQUE, GEOMETRY, CALLIGRAPHY(1I); LOTUS BUD(2P); ARABESQUE, GEOMETRY, CALLIGRAPHY(2I); ARABESQUE, GEOMETRY, CALLIGRAPHY(3I)

L1. M (wood), D (decorated with arabesque, geometry, calligraphy)	
I: Form	Primary (cylindrical: voluminous, closed, stylised, dynamic, 2-3 dimensional)
E: Value (dark), P: Size (big)	
A2. M (wood), D (decorated with lotus bud, geometry, calligraphy), Ch (anti-natural, continuous, curved, geometrical, infinite, regular, repetitive, rhythmic)	
G3. M (wood), D (decorated with lotus bud, arabesque, calligraphy), Ch (abstract, circular, continuous, geometric, repetitive, rhythmic, symmetric)	
C4. M (wood), D (decorated with arabesque, calligraphy), Ch (curved, geometric, linear, mathematical, mystical)	

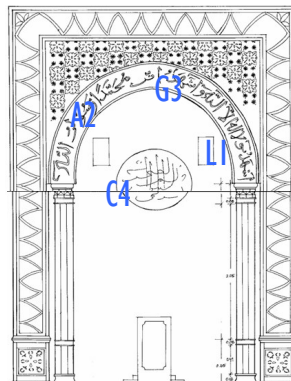

Mihrab (5600 x 4330 cm)



### 37. Sabilliah Malang, Malang, East Java (1974)



Location: Sub-district of Klojen, Malang. Founder: the Committee of Blimbing Sabilliah Malang Mosque

The mosque has 1,800 m<sup>2</sup>. The prayer hall made of a concrete roof. It is named “Raya Sabilillah mosque” to remember Muslim fighters against the Dutch. In the prayer hall, tall columns with natural lotus buds are stretching up, while Islamic ornament covers the whole façade of the mihrab, reminding of the *horror vacui* (dread for empty) principle in Islamic ornament. Beautifully combined ornamentation of naturalism and abstraction can see overall.

CODES: LOTUS BUD, SCROLL(1P); GEOMETRY, CALLIGRAPHY(1I); LOTUS BUD, SCROLL(2P); GEOMETRY, CALLIGRAPHY(2I); GEOMETRY(4I)

L1. M (wood, glass), D (decorated with scroll, calligraphy)	
I: Form	Non-primary (slender, open, realistic, dynamic, 2-3 dimensional)
E: Value (dark), P: Size (big)	
S2. M (wood), D (decorated with lotus bud, calligraphy)	
I: Rhythm	Regular (horizontal, diagonal: repetitive, harmonious, single, strong, continuous)
E: Texture (smooth), P: Proportion (non-progressive)	
G3. M (wood; tile), D (decorated with calligraphy), Ch (abstract, circular, continuous, geometric, regular, repetitive, symmetric)	
C4. M (tile), D (decorated with geometry), Ch (curved, geometric, linear, mathematical, mystical)	

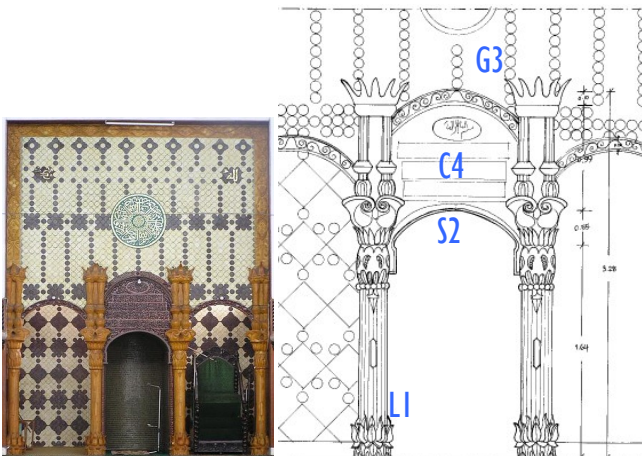

Mihrab (3280 x 2480 cm)



### 38. Al Ukhuwah Balai Kota, Bandung, West Java (1990)



Location: Bandung. Founder: MUI and Bandung district. Architect: E. Kulman.

The mosque has a rectangular form with a piled roof of the steel structure. It has no columns. Of the three floors, the basement is for car parking, ablution, administration, a bank, and shops. The ground floor is for prayer and the library. Friday prayer can be extended outside the serambi, accommodating 4,000 people. The whole interior aesthetically combines with orthodox Islamic ornaments, such as arabesque, geometry, and calligraphy, but Hindu-Buddhist scroll executed by a technique of arabesque on the mihrab shows an influence from the temple ornamentation.

CODES: SCROLL/ARABESQUE, GEOMETRY, CALLIGRAPHY(11); ARABESQUE, CALLIGRAPHY(21); ARABESQUE(31)

S/AI. M (wood), D (decorated with geometry, calligraphy)	
I: Rhythm	Irregular (non-repetitive, disharmonious, multiple, weak, discontinuous)
E: Texture (rough), P: Proportion (non-progressive)	
G2. M (plaster), D (decorated with scroll/arabesque, calligraphy), Ch (abstract, circular, continuous, geometric, linear, mathematical, mystical, regular, repetitive, rhythmic)	
G3. M (plaster; wood), D (decorated with scroll/arabesque, geometry), Ch (curved, geometric, linear, mathematical, mystical)	

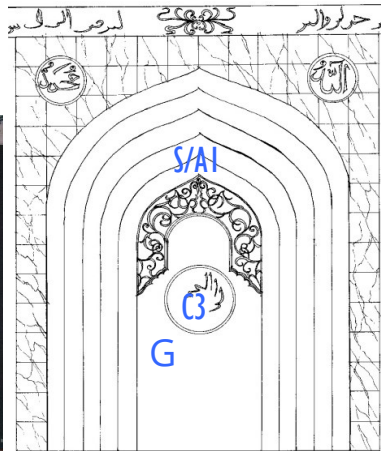
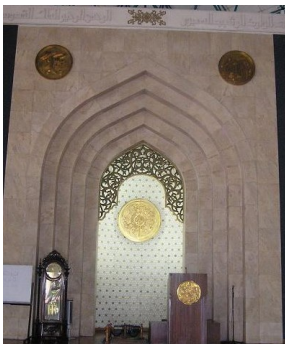

Mihrab (8400 x 7200 cm)

**39. Al Akbar Surabaya, Surabaya, East Java (1995-2000)**



Location: Sub-district of Pagesangan, Surabaya. Founder: Tarmizi Taher, Marie Muhammad, etc.

Architect: Team ITS.

The mosque is located at the edge of a highway between Surabaya and Malang. It is a contemporary mosque of a rectangular shape and a dome with modern technology, which made of six-layered steel.

And the prayer hall does not have a column; thus devotees can watch the mihrab without obstacles. The mosque has an identity as a ‘city mosque’ of Surabaya harbour where pilgrims embarked in earlier days. Although the whole impression is Islamic architecture, details inside and outside the mosque reveal the use of local motifs, explaining a strong tradition of keeping cultural heritage.

**CODES: GEOMETRY, CALLIGRAPHY(11); GEOMETRY, CALLIGRAPHY(21)**

G1. M (wood), D (decorated with calligraphy), Ch (abstract, circular, continuous, geometric, repetitive, rhythmic)
C2. M (wood), D (decorated with geometry), Ch (curved, geometric, linear, mathematical, mystical)

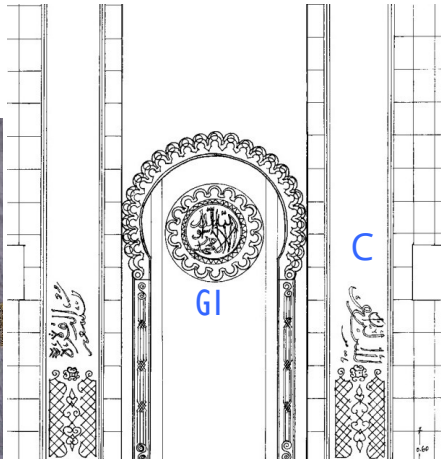

Mihrab (6100 x 6400 cm)

**40. Pusdai, Bandung, Java West (1996)**



Location: Dipenogoro Street, Bandung district. Founder: MUI and local government. Planer: PT. Arsiplan.

The mosque complex was built as a centre for prayer and Islamic teaching. It divides into four main buildings: the mosque, including a plaza, multi-functional room, administration, and exhibition hall. Although orthodox Islamic ornament is favourite, a strong traditional touch shows on a choice of motif and its excellent execution. The massive size of the qibla wall contains a mihrab and a minbar. Stained glass and calligraphy on it can imply the mystery of Allah, calling all attention during prayer.

CODES: LOTUS BUD(1P), ARABESQUE, GEOMETRY, CALLIGRAPHY(11); ARABESQUE, GEOMETRY, CALLIGRAPHY(21); ARABESQUE, GEOMETRY, CALLIGRAPHY(31); ARABESQUE, GEOMETRY, CALLIGRAPHY(41)

L1. M (wood, glass), D (decorated with scroll, geometry)	
I: Form	Primary (cylindrical; voluminous, closed, stylised, dynamic, 2-3 dimensional)
E: Value (dark), P: Size (big)	
A2. M (wood), D (not decorated), Ch (circular, continuous, curved, geometrical, repetitive, rhythmic)	
G3. M (glass; iron; stone), D (decorated with calligraphy), Ch (abstract, geometric, mathematical, mystical, rhythmic)	
C4. M (glass; wood), D (decorated with geometry), Ch (curved, geometric, rectilinear, mystical)	



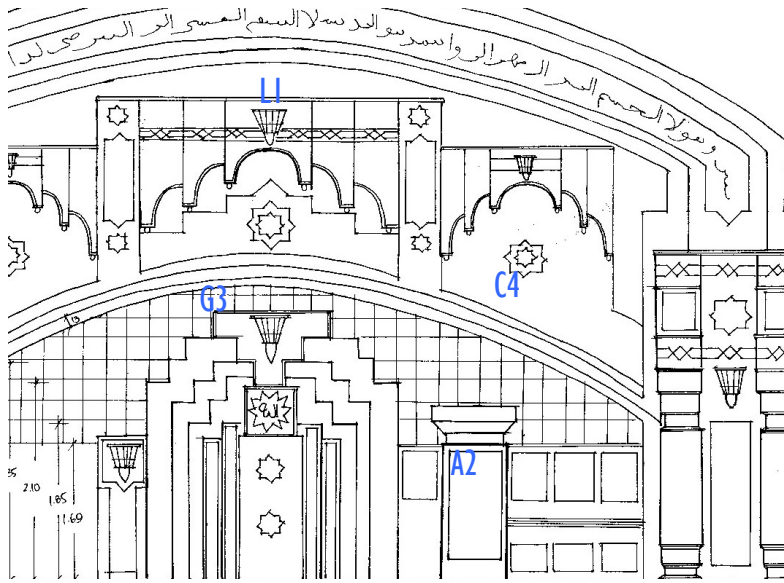

Mihrab (inside: 2100 x 2960 cm)

**No Mihrab: Pondok Indah, Jakarta, Java West (1990)**

Location: Pondok Indah complex, Jakarta. Architect: Perentjanaan Djaya, PT.



The mosque has 6,000 m<sup>2</sup> with modern architecture. A blue roof with 45° underlines a ‘tropic’ region, taken from Javanese traditional piled-roof. On the ground floor, there are a multifunctional room and wudhu for ablution. The uniqueness of the mosque is the absence of mihrab. It intentionally does, because the architect follows the first mosque of the Prophet in Medina which lacks a mihrab. Qibla is horizontally made and in the middle part, minbar stands. Contrary to other mosques, this mosque has open doors in three directions to extend the space. Against the sensitive weather, partitions are placed to make inside cooler. Another distinct feature is a 50 m minaret. Both in the interior and exterior of the mosque, abstract and geometric Islamic ornament fills the vast, but empty space.

# G L O S S A R Y

*Acanthus*: Mediterranean leaf, the most preferred ornamental motif in religious architecture in the West.

*Antefix*: triangular element, carved in a variation on the tops of walls and cornices in Hindu-Buddhist temples.

*Arabesque*: stylised and geometrical leaves forming a continuous pattern composed of the acanthus, vine, and palmette. It is one of three important Islamic ornaments, along with geometry and calligraphy.

*Bodhisattva*: a being who searches for the attainment of the Buddhahood for the benefit of all sentient beings. This concept, central to the Mahayana School, developed from the original idea of one who defers the 'ultimate goal' of Nirvana (extinction).

*Candi*: Hindu temple for keeping ashes of the king. In Java, it can be a sepulchral monument.

*Candi bentar*: split-gate, a gateway consisting of two separate, symmetrical parts flanking the entrance to a temple. If placed together, these two parts would form the outline of a candi.

*Candrasengkala*: chronogram in Java to indicate the year. In it, four digits together form a year of the Saka.

*Dharma*: a mystical doctrine which contains the part of the liberation from the life cycle to attain Enlightenment through the way of Buddha.

*Gamelan*: ancient Javanese xylophone music instrument.

*Garuda*: Hindu bird, sometimes accompanied by Vishnu. The reverence for the garuda in Indonesia might refer to a much earlier bird cult.

*Hadith*: Sayings of the Prophet Muhammad.

*Hijrah*: the Prophet's migration from Mecca to Medina in 622, counted as the first year of the Islamic calendar.

*Horror Vacui*: the dread of empty spaces. Covering the surface fully is one of the principles of Islamic art.

*Imam*: religious leader in prayer.

*Kaa'ba*: the edifice situated in Mecca, which is the liturgical centre of Islam and towards Muslims pray.

*Kala*: literally 'time', 'death', or 'black'. The name is given to a demon mask mounted above doorways and niches in Hindu-Buddhist temple with makara. They often appear to mihrabs in mosques.

*Koran*: God's message given to Muslims through the Prophet Muhammad: Book of Revelation.

*Kraton*: Javanese palace.

*Kufic*: script type of Arabic calligraphy. Named from the Iraq city of Kufa, it was used in the Koran, due to its vertical strokes and largely geometric configuration.

*Kul-kul*: split wooden block, beaten to give signals for calling meetings and alarms.

*Limasan roof*: pyramid form of Javanese roof construction.

*Majapahit*: Hindu kingdom in East Java in the 15<sup>th</sup> century.

*Mahayanist*: Mahayana (Great Vehicle) or Northern branch is one of the two major divisions of Buddhism, the other being Theravada (or Hinayana—Small Vehicle). Mahayana Buddhism is based on sophisticated metaphysical speculations regarding the nature of Reality, or Enlightenment and of the Buddha.

*Majapahit*: Hindu kingdom in East Java in the 15<sup>th</sup> century.

*Makara*: mythical aquatic beast, probably a combination of a fish and the elephant's trunk. With kala, it is used to frame doorways and niches of temples.

*Masjid*: a place for prayer.

*Meru*: sacred structure in Hindu-Javanese temple, by its multi-layered roof, usually in odd numbers.

*Mihrab*: prayer niche in the centre of the western wall of the mosque used for the Imam, indicating the direction of Mecca. In general, it has an arched form decorated with different ornaments.

*Minaret*: a tower for calling Muslims to pray. In Indonesia, the drum is used, instead.

*Minbar*: pulpit where the Imam preaches.

*Mustaka*: ornaments on top of the meru in a mosque or cungkup building in the form of a Hindu crown.

*Naga*: mythical serpent, sometimes resembling a dragon.

*Padma*: lotus.

*Paduraksa*: gate with a roof and double-door, where much ornamentation is applied.

*Palmette*: pseudo-leaf of Sasanian origin.

*Pasisir*: coastline of the northern part of Java where Islam started in the 15<sup>th</sup> century.

*Pawstren*: prayer place for women, separated from the prayer hall in a mosque.

*Qibla*: the direction of Mecca towards which Muslims turn in prayer.

*Saka*: the era of Indian chronology, used in Indonesia during the classical period. The era was assumed to have started in A.D. 79; five hundred years after the birth of the Buddha.

*Serambi*: veranda.

*Shariah*: canonical law based on the Koran and Sunna guidance and governing all religious and secular duties and prohibitions.

*Soko Gura*: four main wood columns of joglo construction of a Javanese structure.

*Sufism*: mystical approach, employing contemplation and ecstatic states to reach communion with the Divine, of Persian origin and much favoured by Muslim poets.

*Surya*: sun, a symbol of the Majapahit kingdom, representing power and supremacy.

*Tawhid*: the divine unity in Islam.

*The Five Principles of Islam*: the confession of faith (Shahadah); the performance of ritual prayer five times a day (Salat); the payment of religious tax (Zakat); observing the fast during Ramadan (Sawm); performing the pilgrimage to Mecca (Haj).

*Tumpal*: the most popular triangular motif from Neolithic and megalithic times, used both in the Hindu-Buddhist and Islamic periods in Indonesia.

*Walis*: saints. Nine saints are called Wali Songo.

*Wudhu*: spiritual washing place. Before prayer, purification rites must be performed to establish the purity of intention. Ordinary water is used.

# R E F E R E N C E S

- Alexander, M. J. (1965), *Handbook of Decorative Design and Ornament*, New York: Tudor Publishing Co.
- Ardalan, Nuder and Laleh Bakhtiar (1973), *the Sense of Unity: The Sufi Tradition in Persian Architecture*, Chicago: Univ. of Chicago Press.
- Ambariy, Hasan Muarif (1998), *Menemukan Peradaban, Arkeologi dan Islam di Indonesia [Finding the Civilisation of Islam and Archaeology in Indonesia]*, Jajat Burhanudin (ed.), Puslit Arkenas.
- Arnheim, R. (1974), *Art and Visual Perception: A Psychology of the Creative Eye*, Berkeley: Univ. of California Press.
- Aubert, Marcel (1959), *Gothic Cathedral of France and Their Treasure*, (trans. Kochan), Paris: Kaye.
- Baer, Eva (1998), *Islamic Ornament*, Edinburgh: Edinburgh Univ. Press.
- Behrens-Abouseif, Doris (1998), *Beauty in Arabic Culture*, Princeton, NJ: Markus Wiener Publishers.
- Bennett, James (2005), *Crescent Moon - Islamic Art and Civilisation in Southeast Asia*, Art Gallery of South Australia.
- Bloomer, Kent (2002), *The Nature of Ornament, Rhythm and Metamorphosis in Architecture*, New York: Norton & Company
- Bosch, F. D. K. (1960), *the Golden Germ: an Introduction to India Symbolism* (trans. A. Fontein), The Hague: Mouton and Co.
- Brend, Barbara (1991), *Islamic Art*, London: British Museum Press.
- Brommer, G. F. (1975), *Movement and Rhythm*, Worcester: Davis Publications Inc.
- Burckhardt, Titus (1976; 1980), *Art of Islam Language and Meaning: The Common Language of Islamic Art*, London: World of Islam Festival Publishing Company Ltd.
- Ching, Francis D. K. (1996), *Architecture, Form, Space, and Order*, New York: Van Nostrand Reinhold.
- Collingwood (1883), *the Philosophy of Ornament*, Orpington, Kent: George Allen, Sunnyside.
- Crane, Walter (1892), *the Claims of Decorative Art*, London.
- Creswell, K. Archibald (1958), *a Short Account of Early Muslim Architecture*, Harmondsworth: Penguin.
- Critchlow, Keith (1976; 1989), *Islamic Patterns, an Analytical Cosmological Approach*, London: Thames & Hudson.
- Davies, J. G. (1982), *Temples, Churches and Mosques, a Guide to the Appreciation of Religious Architecture*, Oxford: Blackwell.
- Day, Lewis F. (1903; 1979), *Pattern Design*, London: B. T. Batsford.
- Dickie, James (1978), *Allah and Eternity: Mosques, Madrasas and Tombs: Architecture of the Islamic World*, (ed) G. Michell, London: Thames & Hudson.
- Focillon, Henri (1989), *the Life of Forms in Art*, New York: Zone Books.
- Fontein, J. (1990), *the Sculpture of Indonesia*, Washington: National Gallery of Art.
- Fox, James (1998), *Religion and Ritual: Indonesian Heritage*, Singapore: Archipelago Press.
- Frishman, M. and Hasan Khan (eds) (1994), *the Mosque: Historical, Architectural Development and Regional Diversity*, London: Thames & Hudson.
- Gatto, Joseph A. (1975), *Emphasis*, Worcester, Mass.: Davis Publications Inc.
- Grabar, Oleg (1973; 1987), *the Formation of Islamic Art*, New Haven and London: Yale Univ. Press.

- Grillo, Paul Jacques (1960; 1975), *Form, Function and Design*, New York: Dover Publications, Inc.
- Hamlin, Alfred D. F. (1916), *A History of Ornament, Ancient & Medieval*, New York.
- Hattstein, Markkus and Peter Delius (eds.) (2000), *Islam Art and Architecture*, Köln: Könemann.
- Heath, Sidney H. (1909), *the Romance of Symbolism, and Its Relation to Church Ornament and Architecture*, London: Francis Griffith.
- Handell, Albert and Leslie T. Handell (1995), *Intuitive Composition*, New York: Watson-Guption Publications.
- Herzfeld (1938), *the Encyclopaedia of Islam*.
- Hillenbrand, Robert (1999), *Islamic Art and Architecture*, London: Thames & Hudson.
- Hillenbrand, Robert (2001a), *Studies in Medieval Islamic Architecture*, vol. I. London: The Pindar Press.
- van der Hoop, A. N. J. Th, a' Th. (1949), *Indonesian Ornamental Design* (trans. E. Power), Koninklijk Bataviaasch Genootschap van Kunsten en Wetenschappen: Bandoeng.
- Hulme, Frederick E. (1893), *the Birth and Development of Ornament*, London: Sonnenschein & Co.
- Insoll, T. (1999), *the Archaeology of Islam*, Oxford: Blackwell.
- Irwin, Robert (1997), *Islamic Art in Context: Art, Architecture and the Literary World*, New York.
- Isnaeni, Hendrajaya (1996), *the Javanese Mosque, a Regional Interpretation of Form and Mystical Concepts*, PhD Thesis, Univ. of Melbourne.
- Jones, Dalu (1978), *the Elements of Decoration-Surface, Pattern and Light: Architecture of the Islamic World*, (ed.) G. Michell, London: Thames & Hudson.
- Jones, Owen (1856; 1982), *Grammar of Ornament*, New York: Van Nostrand Reinhold Company.
- Kempers, Bernet A. J. (1959), *Ancient Indonesian Art*, Cambridge: Harvard Univ. Press.
- Koentjaraningrat (1990), *Javanese Culture*, Singapore: Oxford Univ. Press.
- Krommenhoek, Hans (1975), *Study Guide for Design One*, Kendall: Hunt Publishing Company.
- Kusno, Abidin (2003), "the Reality of One-Which-is-Two: Mosque Battles and Other Stories, Notes on Architecture, Religion and Politics in the Javanese World", *Journal of Architectural Education, ACSA*, pp.57-67.
- Kuhnel, Ernst (1949; 1977), *the Arabesque: Meaning and Transformation of an Ornament* (trans. R. Ettinghausen), Graz: Verlag fur Sammler.
- Lee, Hee Sook (2001), *Arabic Calligraphy as an Illustrative Tool for Religious and Applied Art in Modern Kuwait*, MA diss. Syracuse University, USA.
- Marcais, Georges (1954), *l'Architecture Musulmane d'Occident*, Paris: Arts et Metiers Graphiques.
- March, Colley (1896) "Evolution and Psychology in Art", *New Series*, Vol. 5, No. 20. (Oct.), Oxford University Press on behalf of the Mind Association
- Marwoto, Irmawati (2003), *Seni Dekoratif Pada Bangunan di Pantai Utara Jawa abad Ke 15-17: Suatu Masalah Penanda Ke-Islaman [Decorative Art in Northern Javanese Coast Construction from the 15 to 17th Centuries: an Islamic Indicator]*, PhD thesis, Univ. of Indonesia.
- Nasr, Seyyed Hossein (1987), *Islamic Art and Spirituality*, Albany: State Univ. of New York Press.
- Mitchell, George (ed.) (1978), *Architecture of the Islamic world: Its History and Social Meaning*, London: Thames & Hudson.
- Naddaff, S. (1991), *Arabesque, Narrative Structure and the Aesthetics of Repetition in 1001 Nights*, Evanston: Northwestern Univ. Press.



- Necipoglu, Gulru and Mohammad al-Asad (1995), *Topkapi Scroll: Geometry and Ornament in Islamic Architecture*.
- O'Neill, Hugh (1994), *South-East Asia: The Mosque, History, Architectural Development and Regional Diversity*, (eds.) M. Frishman and H. U. Khan, London: Thames & Hudson.
- Papadopoulo, Alexandre (1988), *le Mihrab dans l'Architecture et la Religion Musulmanes, actes du colloque international tenu a Paris en Mai 1980*, Leiden: Brill.
- Porphyrios, D. (1991), *Classical Architecture*, London: Academy Editions.
- Prijotomo, Josef (1992), *Ideas and Forms of Javanese Architecture*, Yogyakarta: Gadjah Mada Univ. Press.
- Prisse, D'Avennes (1983), *Arab Art: as Seen Through the Monuments of Cairo from the 7th to the 18th Century* [trans. J. I. Erythrospis], Paris: Le Sycomore and Al Saqi Books.
- Riegl, Alois (1893; 1992), *Problems of Style: Formation for a History of Ornament* (trans. Evelyn Kain), New Jersey: Princeton Univ. Press.
- Rogers, J. M. (2005), *the Timeline History of Islamic Art and Architecture*, Hertfordshire: Worth Press Ltd.
- Rutherford, Scott (ed.) (1996), *Insight Guides Indonesia*, Hong Kong: Aga Publications Ltd.
- Seckel, Dietrich (1964), *the Art of Buddhism* (trans. Ann E. Keep), London: Methuen.
- Smeets, Rene (1975), *Signs, Symbols and Ornament*, New York: Van Nostrand Reinhold.
- Snodin, Michael and M. Howard (1996), *Ornament-A Social History since 1450*, London: New Haven and Yale Univ. Press.
- Stierlin, Henri (1996), *Islam, Early architecture from Baghdad to Cordoba*, Köln: Taschen.
- Stoops, Jack (1983), *Design Dialogue*, Worcester: Davis Publications Inc.
- Subarna, Abay D. (1982-3), *Contribution a l'Etude de l'Art et de l'Architecture de la Premiere Periode d'Islamisation en Indonesie*, PhD Thesis, Univ. of Paris in Pantheon Sorbonne.
- Sudradjat, Iwan (1991), *a Study of Indonesian Architectural History*, PhD Thesis, Univ. of Sydney.
- Tjahjono, Gunawan (1998), *Architecture: Indonesian Heritage*, Singapore: Archipelago Press.
- Tjandrasasmita, Uka (1985), "le Role de l'Architecture et des Arts Decoratifs dans l'Islamisation de l'Indonesie" (trans. Guillot. C.), *Archipel*. No. 29, pp.29-35.
- Trilling, James (2001), *the Language of Ornament*, London: Thames & Hudson.
- Wafi, Abdel Majid (1988), *les Mihrab et leurs Ornamentations Decoratives: le Mihrab dans l'Architecture et la Religion Musulmanes, actes du colloque international tenu a Paris en Mai 1980*, (ed) Papadopoulo, A. Leiden: Brill.
- Wagner, Frits A. (1959), *Indonesia, the Art of an Island Group*, New York: Crown Publishers, Inc.
- Yeomans, Richard (1999), *the Story of Islamic Architecture*, New York: Garnet Publishing.
- Zimmer, H. Robert (1960), *the Art of Indian Asia*. Bollingen Series XXXIX, N.Y., Princeton: Princeton Univ. Press.



Detailed information on The Continuity of Pre-Islamic Motifs in Javanese Mosque Ornamentation, Indonesia can be found in a Korean book version, called “Syncretic Architectural Heritage in Javanese Islam”. Published by Korean Studies Information, 2015. <http://ebook.kstudy.com>

Dr Hee Sook Lee-Niinioja is a scholar/journalist/artist/designer. As an international pioneer student in Scandinavia in the 1970s, she has educations in journalism (South Korea), art-design (Norway), visual communication (USA), architecture (UK), besides theology, literature, etc. She has exhibited "Goethe in Me" and presented academic researches. She published journalistic articles and books on her specialisations on 'Hindu-Buddhist, Christian and Islamic architecture', 'cultural heritage', and 'colour and emotions', hoping to enhance dialogues through the commonness. She volunteered to humanitarian works while teaching at institutes across the globe. She received awards and appreciations, including the Civil Merit from the President of South Korea.



NOVEL & NOBLE COMMUNICATIONS